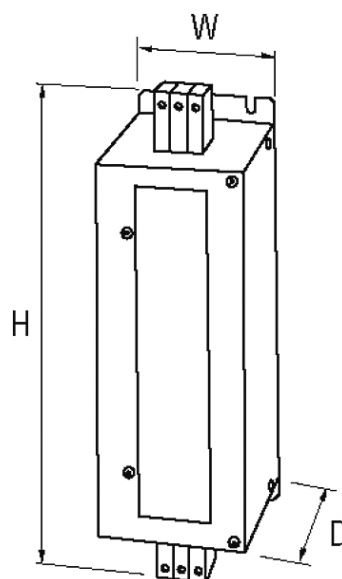

MEF EMC-FILTER 3-PHASE 1-STAGE

I:180A U:3x600 VAC book-style

Current: 180 A
1-stage

Attenuation curves on request.

[Link to Product](#)**Illustration**

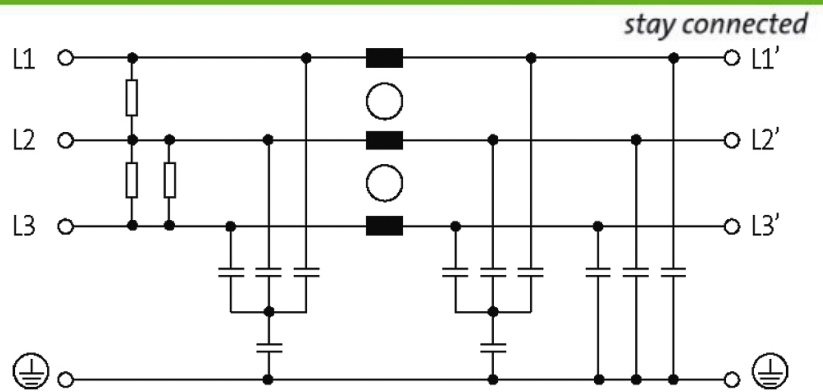

Product may differ from Image

Approvals



Technical Data

Operating voltage	max. 3 × 600 V AC
Operating frequency	50...60 Hz
Overload current	18 × (IN t) max. 0.5 ms; 1.5 × (IN t) max. 1 min. (1 × per hour)
Consumption	max. 10 mA (250 V AC)
Connection cross section	25...95 mm ² single core (AWG 3...0000); 35...95 mm ² multiple core (AWG 2...0000)

General data

Climatic category	25/085/21 (EN 60068-1)
Test isolation voltage	3.3 kV (L - N), 2 s; 3.1 kV (L -L), 2 s
Connection	Screw connection, touch protected
Mounting method	screw fixing
Dimensions H × W × D	380×120×170 mm

Description

Functional description	The 3-phase and 1-/2-stage EMC filters MEF 3/1-3/2 are used in the range 0.1...30 MHz and dampen interferences found in cables from the mains, supply units and control systems. They are suitable for TN-C-mains. The best results are obtained with short con
------------------------	---

Commercial data

country of origin	IT
customs tariff number	85363090
EAN	4048879029186
eClass	27130806
Packaging unit	1