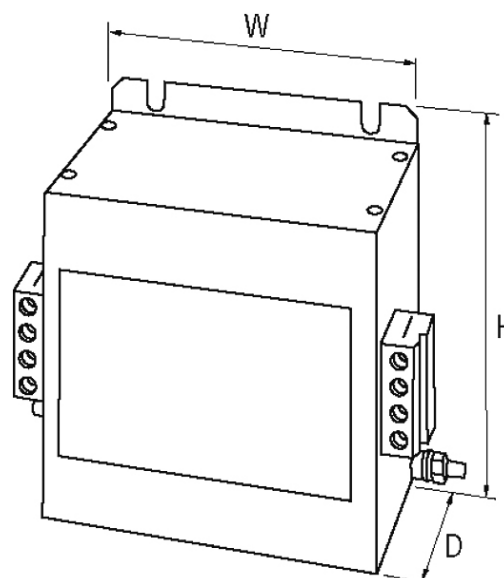

**MEF EMC-FILTER 3-PHASE 1-STAGE WITH NEUTRAL**

I:100A U:4x500 VAC

Current: 100 A  
with neutral  
with increased damping

Attenuation curves on request.

[Link to Product](#)**Illustration**

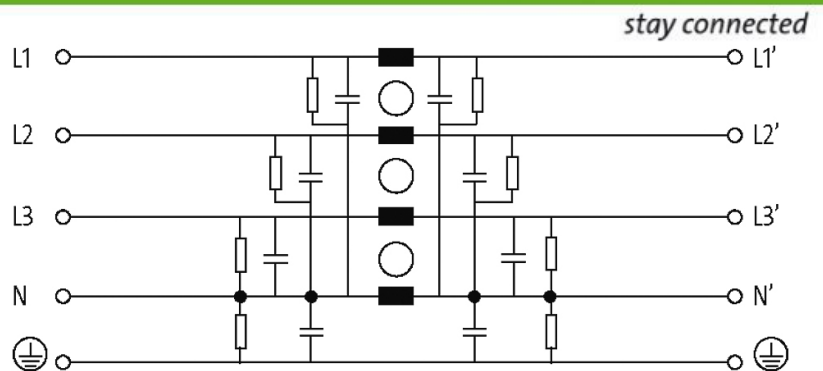

Product may differ from Image

## Approvals



## Technical Data

Connection cross section	6...35 mm <sup>2</sup> single core (AWG 9...2); 10...35 mm <sup>2</sup> multiple core (AWG 7...2)
Operating voltage	max. 3 × 500 V AC
Operating frequency	50...60 Hz
Consumption	max. 15 mA (250 V AC)
Overload current	18 × (IN t) max. 0.5 ms; 1.5 × (IN t) max. 1 min. (1 × per hour)

## General data

Mounting method	screw fixing
Dimensions H × W × D	170×180×140 mm
Climatic category	25/085/21 (EN 60068-1)
Test isolation voltage	3.3 kV (L - N), 2 s; 3.1 kV (L - L), 2 s

## Description

### Functional description

The 3-phase and one-stage EMC filters MEF 3/1 are used in the range 0.1...30 MHz and dampen interferences found in cables from the mains, supply units and control systems. They are suitable for TN-S, TN-C-S, and TT networks. The best results are obtained

## Commercial data

country of origin	IT
customs tariff number	85363030
EAN	4048879029063
eClass	27130806
Packaging unit	1