

MVP12, 4XM12, 5POLE, BASIC HOUSING

Without cap, with potent. sep.

4-way, 5-pole

Potential separation as option

Plastic housings with good resistance against chemicals and oils. The resistance to aggressive media should be individually tested for your application. Further details on request. Further cable lengths on request.

[Link to Product](#)

Illustration



M12 Females 5-pole

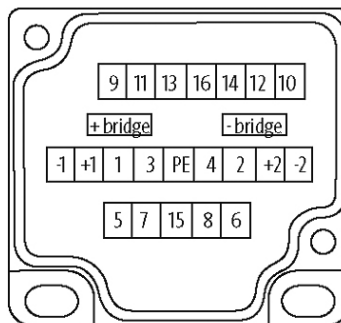
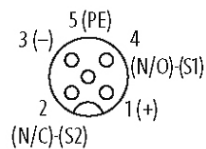

for 2 signals per port

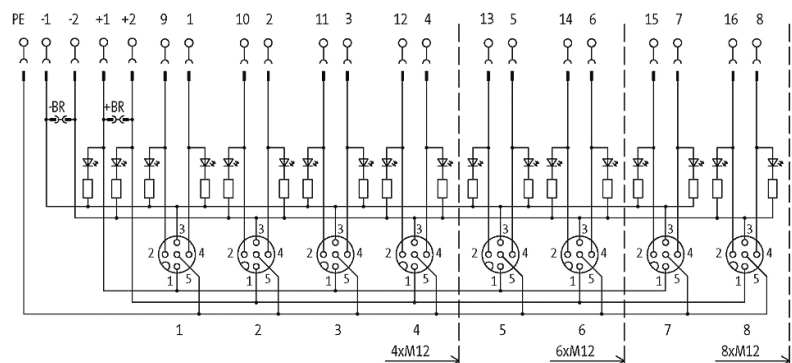
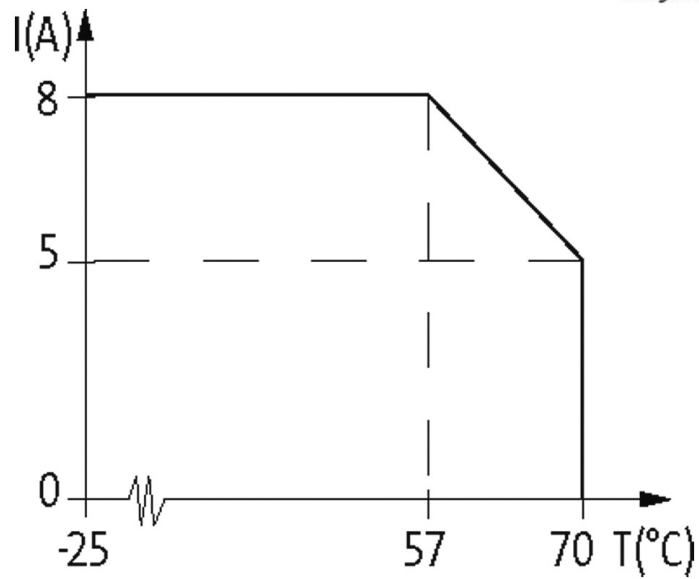

Product may differ from Image

Approvals



Contact Layout

PIN 1	(+)
PIN 2	(NC)/(S2)
PIN 3	(-)
PIN 4	(NO)/(S1)
PIN 5	(Earth)
LED display	LED (green): Power / LED (yellow): (S1/S2)

Technical Data

Operating voltage	24 V DC
Operating current per contact	max. 4 A
Total current	max. 2 × 8 A
Signal per port	2

Locking of ports	Screw thread M12 x 1 mm
Housing	Plastic, flame retardant
Protection	IP67 inserted and tightened (EN 60529)

General data

Temperature range	-20...+80 °C
Dimensions H x W x D	99.2x50.2x17.2 mm

Commercial data

country of origin	DE
customs tariff number	85369010
EAN	4048879064132
eClass	27279219
Packaging unit	1