

MVP12, 8XM12, 5POLE, PLUG. TERM.

W/o cap, with pot. separation, w/o LED's

8-way, 5-pole

Basic module without LED

Potential separation as option

Plastic housings with good resistance against chemicals and oils. The resistance to aggressive media should be individually tested for your application. Further details on request. Further cable lengths on request.

[Link to Product](#)**Illustration**

M12 Females 5-pole

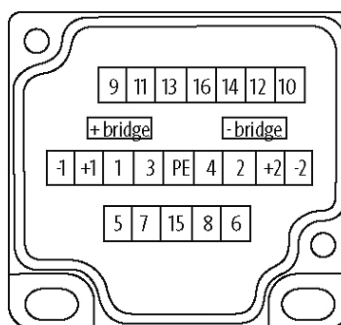
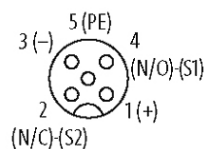

for 2 signals per port

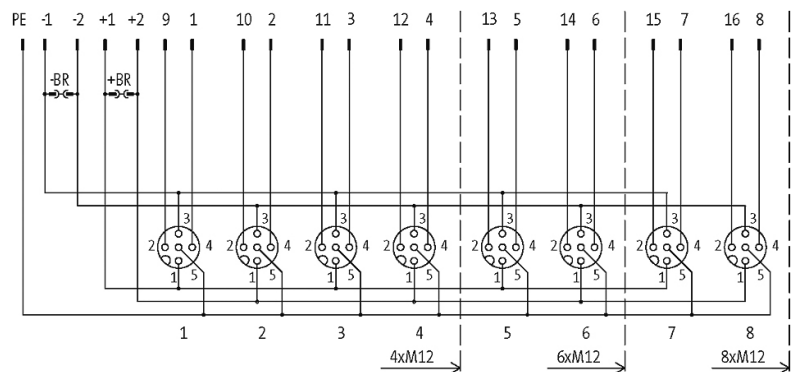
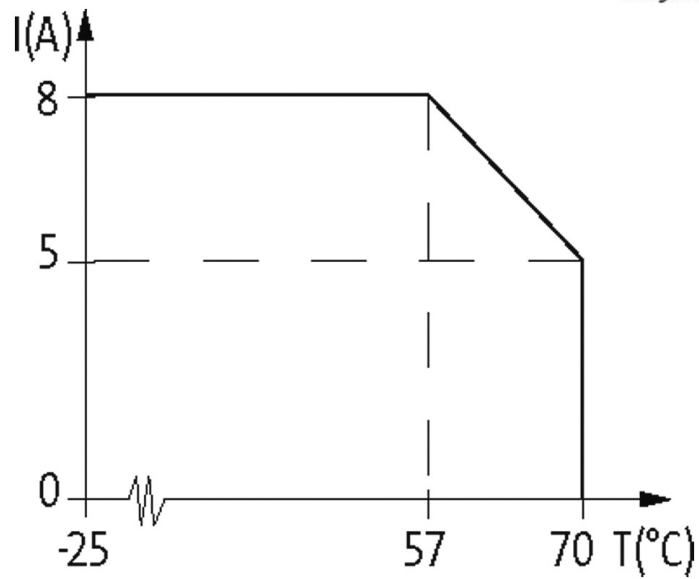

Product may differ from Image

Approvals



Contact Layout

PIN 1	(+)
PIN 2	(NC)/(S2)
PIN 3	(-)
PIN 4	(NO)/(S1)
PIN 5	(Earth)

Technical Data

Operating voltage	24 V DC
Signal per port	2
Operating current per contact	max. 4 A
Total current	max. 2 × 8 A
Housing	Plastic, flame retardant

The information in this brochure has been compiled with the utmost care.

Liability for the correctness completeness and topicality of the information is restricted to gross negligence. Version: 03/19

Murrelektronik GmbH | Falkenstraße 3 | 71570 Oppenweiler | Fon +49 (71 91) 47-0 | Fax +49 (71 91) 47-491000 | shop@murrelektronik.com | shop.murrelektronik.com

Protection	IP67 inserted and tightened (EN 60529)
------------	--

Locking of ports	Screw thread M12 × 1 mm
------------------	-------------------------

General data

Temperature range	-20...+80 °C
-------------------	--------------

Dimensions H × W × D	149.2×50.2×16.5 mm
----------------------	--------------------

Commercial data

country of origin	DE
-------------------	----

customs tariff number	85369010
-----------------------	----------

EAN	4048879061667
-----	---------------

eClass	27279219
--------	----------

Packaging unit	1
----------------	---