

MVP12, 6XM12, 5POLE, PLUG. CAP SPT

Plug. cap, field-wireable via spring terminals

6-way, 5-pole

Spring clamp plug-in terminals

Potential separation as option

Plastic housings with good resistance against chemicals and oils. The resistance to aggressive media should be individually tested for your application. Further details on request.

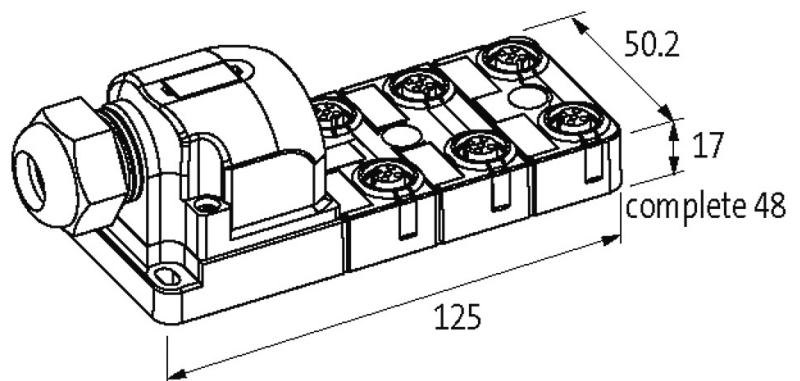
[Link to Product](#)**Illustration**

M12 Females 5-pole

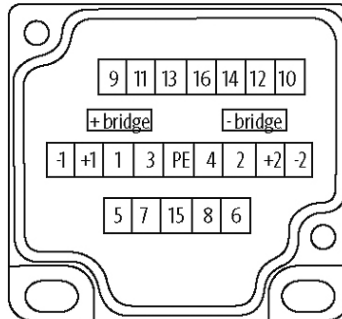
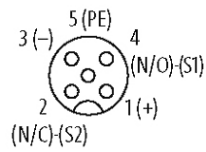

for 2 signals per port

Product may differ from Image

Approvals



Contact Layout

PIN 1	(+)
PIN 2	(NC)/(S2)
PIN 3	(-)
PIN 4	(NO)/(S1)
PIN 5	(Earth)
LED display	LED (green): Power / LED (yellow): (S1/S2)

Technical Data

Operating voltage	24 V DC
Signal per port	2
Operating current per contact	max. 4 A
Connection	Spring clamp plug-in terminals: max. 1.5 mm ² (AWG 16)
Total current	max. 2 × 8 A
Housing	Plastic, flame retardant
Protection	IP67 inserted and tightened (EN 60529)
Locking of ports	Screw thread M12 × 1 mm

General data

Temperature range	-20...+80 °C
Dimensions H × W × D	125×50.2×17 mm

Commercial data

country of origin	DE
-------------------	----

customs tariff number	85369010
EAN	4048879063357
eClass	27279219
Packaging unit	1