

**PASSIVE-DI0° PLASTIC,4XM12.4POL,PRE-WIRED CABLE**

5.0m PUR-JB 4\*0,34+3\*0,75

4-way, 4-pole

PUR/PVC

5.0 m

with LED for digital PNP-signals 24 V DC

Further cable lengths on request. Plastic housings with good resistance against chemicals and oils. The resistance to aggressive media should be individually tested for your application. Further details on request.

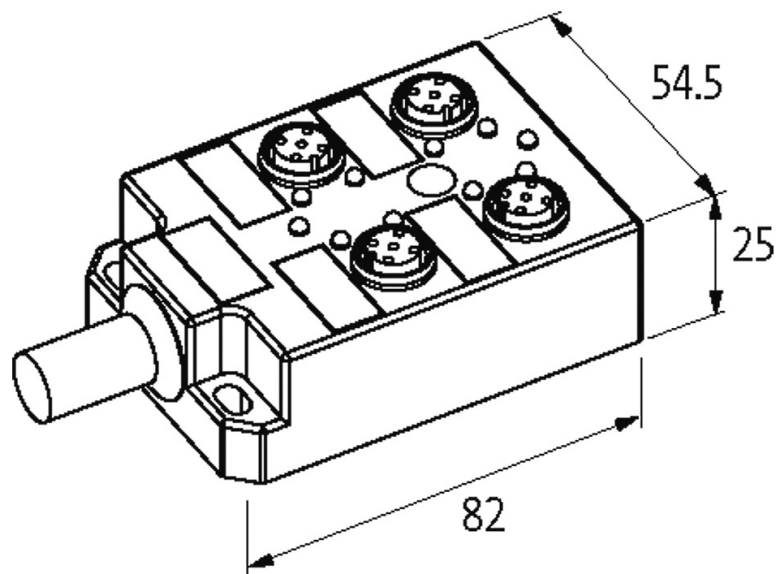
[Link to Product](#)**Illustration**

# M12 Females 4-pole

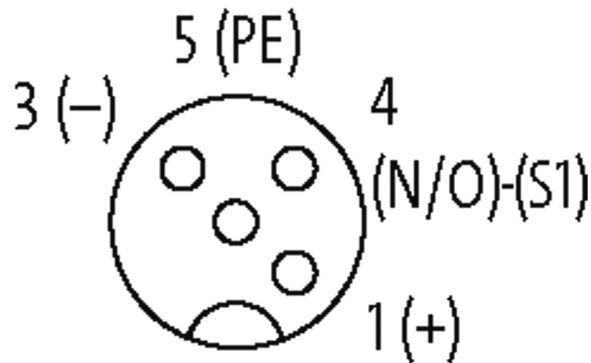

Product may differ from Image

## Contact Layout

PIN 1	(+)
PIN 3	(-)
PIN 4	(NO)/(S1)
PIN 5	(Earth)
LED display	LED (green): Power / LED (yellow): (S1)

## Cables

Cable number	333
No./diameter of wires	4×0.34 + 3×0.75 mm <sup>2</sup>
Wire isolation	PVC
C-track properties	2 Mio.
Jacket Color	gray
Material (jacket)	PUR/PVC
Outer Ø	7.4 mm ±5%
Bend radius (moving)	12 × outer Ø
Temperature range (fixed)	-30...+80 °C
Temperature range (mobile)	-5...+80 °C
Cable identification	333
Cable Type	2 (PUR/PVC)
Approval (cable)	UL (AWM-Style 21441/10955), CE conform
Cable weight [g/m]	91,3
Material (wire)	Cu wire, bare
Resistor (core)	max. 57 Ω/km (0.34 mm <sup>2</sup> ), max. 26 Ω/km (0.75 mm <sup>2</sup> ); (20 °C)
Single wire Ø (core)	0.15 mm (0.34 mm <sup>2</sup> ); 0.2 mm (0.75 mm <sup>2</sup> )
Construction (core)	19 × 0.15 mm (0.34 mm <sup>2</sup> ); 24 × 0.2 mm (0.75 mm <sup>2</sup> ); (wire class 5)
Diameter (core)	4×0.34 + 3×0.75 mm <sup>2</sup>
AWG	similar to AWG 22 (0.34 mm <sup>2</sup> ); similar to AWG 18 (0.75 mm <sup>2</sup> )

The information in this brochure has been compiled with the utmost care.

Liability for the correctness completeness and topicality of the information is restricted to gross negligence. Version: 03/19

Murrelektronik GmbH | Falkenstraße 3 | 71570 Oppenweiler | Fon +49 (71 91) 47-0 | Fax +49 (71 91) 47-491000 | shop@murrelektronik.com | shop.murrelektronik.com

Material (wire isolation)	PVC
Material property (wire isolation)	CFC-, cadmium-, silicone- and lead-free
Shore hardness (wire isolation)	43 ±5 D
Wire-Ø incl. isolation	1.3 mm ±5% (0.34 mm <sup>2</sup> ); 1.8 mm ±5% (0.75 mm <sup>2</sup> )
Shield	no
Material (jacket)	PUR/PVC
Shore hardness (jacket)	87 ±5 A
Outer-Ø (jacket)	7.4 mm ±5%
Color (jacket)	gray
chemical resistance	good resistance to oil, gasoline and chemicals (EN 60811-404)
Nominal voltage	U0/U 300/300 V AC
Test voltage	2 000 V AC
Current load capacity	to DIN VDE 0298-4
Temperature range (fixed)	-30...+80 °C
Temperature range (mobile)	-5...+70 °C
Bend radius (fixed)	5 × outer Ø
Bend radius (moving)	12 × outer Ø
No. of bending cycles (C-track)	max. 2 Mio. (25 °C)
Traversing distance (C-track)	max. 5 m (horizontal)
Travel speed (C-track)	max. 2 m/s
Acceleration (C-track)	max. 10 m/s <sup>2</sup>

#### Technical Data

Operating voltage	24 V DC
Operating current per contact	max. 4 A
Total current	max. 10 A
Signal per port	1 - (31-32)
Locking of ports	Screw thread M12 × 1 mm

#### General data

Protection	IP67 inserted and tightened (EN 60529)
Dimensions H × W × D	82×54.5×25 mm
Temperature range	-20...+80 °C

#### Commercial data

country of origin	CZ
customs tariff number	85444290
EAN	4048879062886
eClass	27279219
Packaging unit	1