

PASSIVE-DI0° PLASTIC,6XM12.4POL,PRE-WIRED CABLE

5.0m PUR-JB 6*0,34+3*0,75

6-way, 4-pole

PUR/PVC

5.0 m

with LED for digital PNP-signals 24 V DC

Further cable lengths on request. Plastic housings with good resistance against chemicals and oils. The resistance to aggressive media should be individually tested for your application. Further details on request.

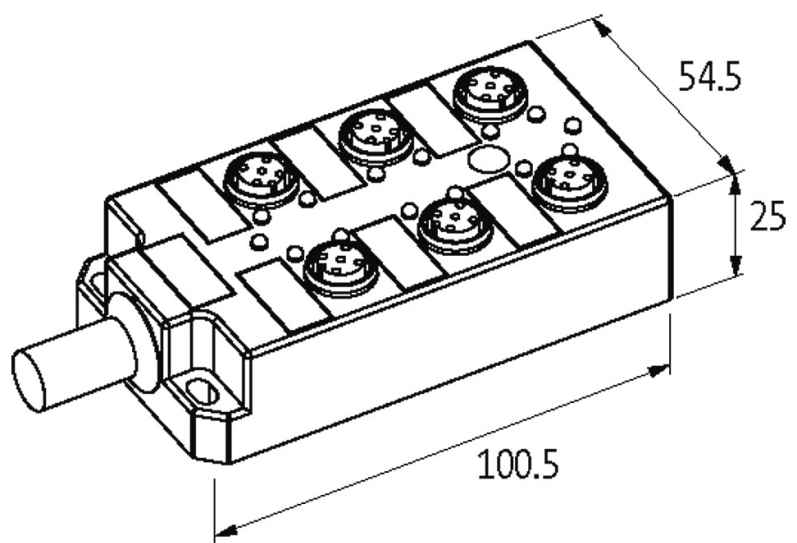
[Link to Product](#)**Illustration**

M12 Females 4-pole

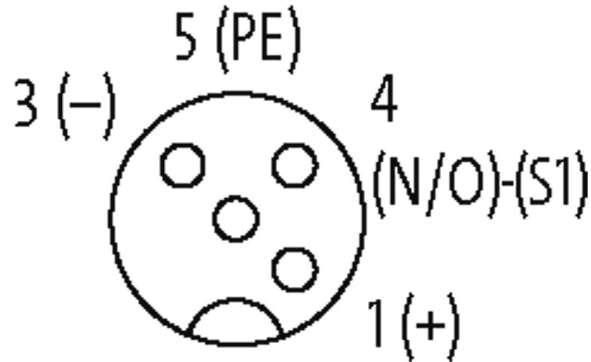

Product may differ from Image

Contact Layout

PIN 1	(+)
PIN 3	(-)
PIN 4	(NO)/(S1)
PIN 5	(Earth)
LED display	LED (green): Power / LED (yellow): (S1)

Cables

Cable number	355
No./diameter of wires	6×0.34 + 3×0.75 mm ²
Wire isolation	PVC (ye, wh, gn, gr, pk, rd+br, bl, gnye)
C-track properties	2 Mio.
Jacket Color	gray
Material (jacket)	PUR/PVC
Outer Ø	9.1 mm ±5%
Bend radius (moving)	12 × outer Ø
Temperature range (fixed)	-30...+80 °C
Temperature range (mobile)	-5...+70 °C
Cable identification	355
Approval (cable)	CE conform
Material (wire)	Cu wire, bare
Color (jacket)	gray
chemical resistance	good resistance to oil, gasoline and chemicals
Nominal voltage	300/300 V AC
Test voltage	2 000 V AC
Temperature range (fixed)	-30...+80 °C
Temperature range (mobile)	-5...+70 °C
Bend radius (fixed)	10 × outer Ø

The information in this brochure has been compiled with the utmost care.

Liability for the correctness completeness and topicality of the information is restricted to gross negligence. Version: 03/19

Murrelektronik GmbH | Falkenstraße 3 | 71570 Oppenweiler | Fon +49 (71 91) 47-0 | Fax +49 (71 91) 47-491000 | shop@murrelektronik.com | shop.murrelektronik.com

No. of bending cycles (C-track)	max. 2 Mio. (25 °C)
---------------------------------	---------------------

Travel speed (C-track)	max. 2 m/s
------------------------	------------

Technical Data

Operating voltage	24 V DC
-------------------	---------

Signal per port	1 - (31-32)
-----------------	-------------

Operating current per contact	max. 4 A
-------------------------------	----------

Total current	max. 10 A
---------------	-----------

Locking of ports	Screw thread M12 × 1 mm
------------------	-------------------------

General data

Dimensions H × W × D	100.5×54.5×25 mm
----------------------	------------------

Protection	IP67 inserted and tightened (EN 60529)
------------	--

Temperature range	-20...+80 °C
-------------------	--------------

Commercial data

country of origin	CZ
-------------------	----

customs tariff number	85444290
-----------------------	----------

EAN	4048879062848
-----	---------------

eClass	27279219
--------	----------

Packaging unit	1
----------------	---