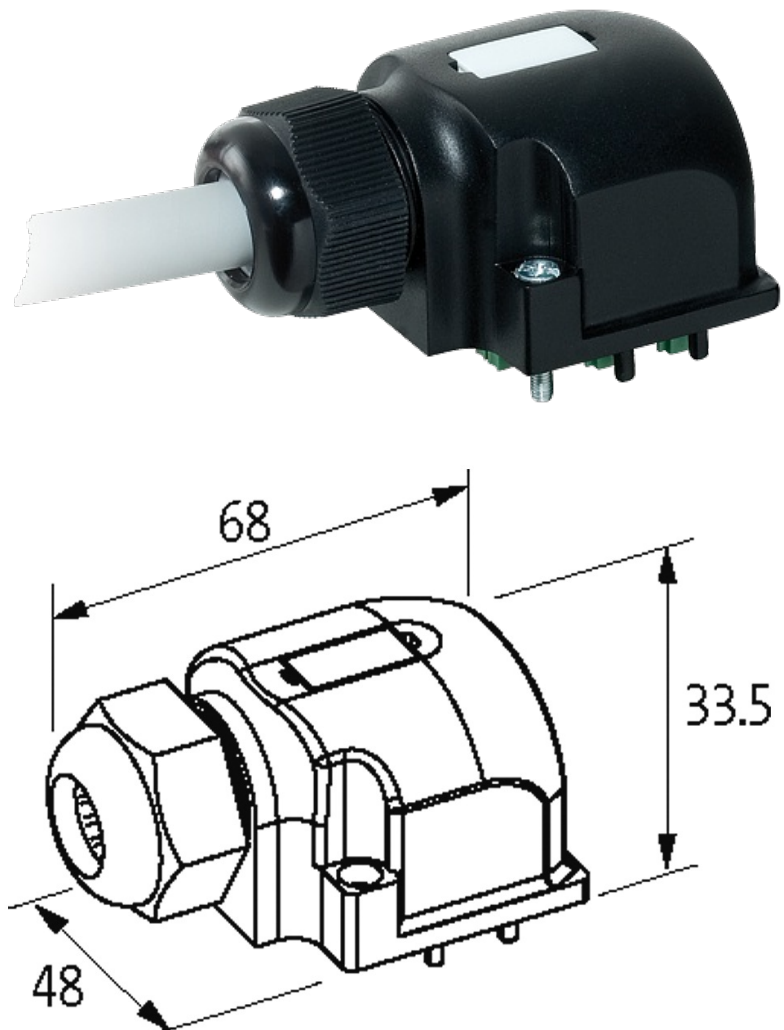

**CAP FOR D-BOX M12 6-WAY 5-POLE**

No pot.-sep. 3m PUR/PVC-JB, 12x0,34+3x0,75

for 6-way distribution boxes, 5-pole  
PUR/PVC  
3.0 m

Plastic housings with good resistance against chemicals and oils. The resistance to aggressive media should be individually tested for your application. Further details on request.

**[Link to Product](#)****Illustration**

Product may differ from image

**Approvals**



### Cables

Cable number	388
No./diameter of wires	12×0.34 + 3×0.75 mm <sup>2</sup>
Wire isolation	PVC (yebr, rd, grpk, wh, rdbl, gn, whgn, ye, brgn, gr, whye, pk, br, gnye, bl)
C-track properties	2 Mio.
Jacket Color	gray
Material (jacket)	PUR/PVC
Outer Ø	9.8 mm ±5%
Bend radius (fixed)	10 × outer Ø
Bend radius (moving)	12 × outer Ø
Temperature range (fixed)	-30...+80 °C
Temperature range (mobile)	-5...+70 °C
Color (jacket)	gray

### Technical Data

Total current	max. 8 A
---------------	----------

### General data

Dimensions H × W × D	33×48×68 mm
----------------------	-------------

### Commercial data

country of origin	CZ
customs tariff number	85444290
EAN	4048879058377
eClass	27143423
Packaging unit	1