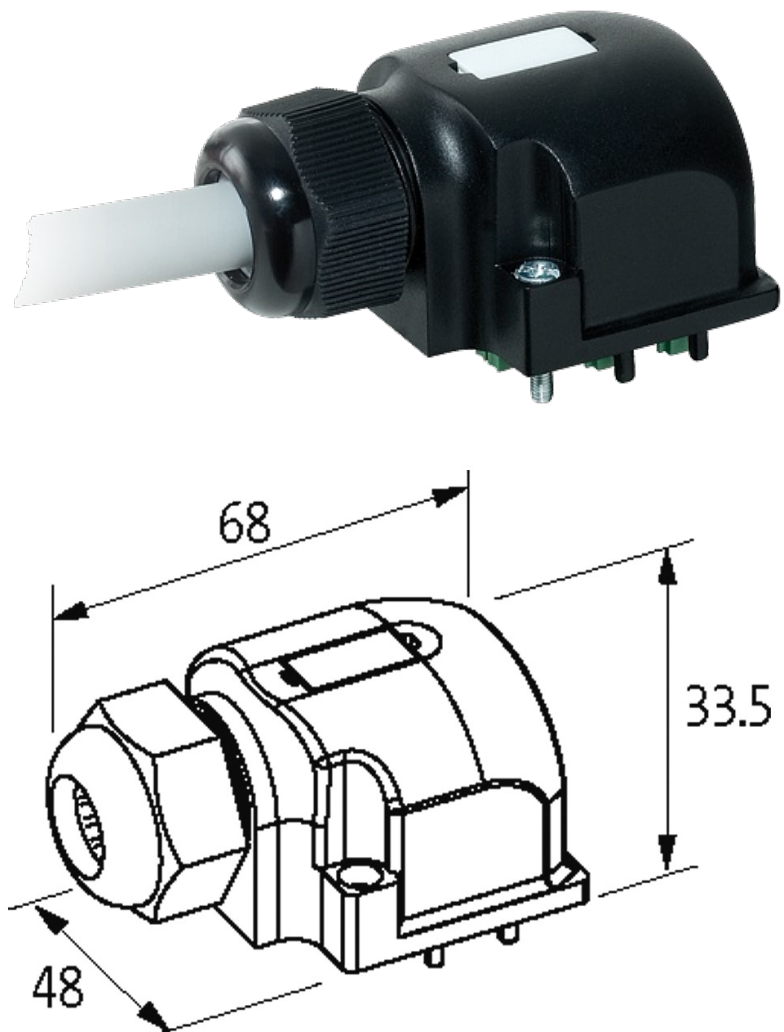

CAP FOR D-BOX M12 8-WAY 5-POLE

Pot.-sep. 5m PUR/PVC-JB, 16x0,34+5x0,75

for 8-way distribution boxes, 5-pole
PUR/PVC
5.0 m
potentially separated
New Art.-No. 8000-88659-4040500

Plastic housings with good resistance against chemicals and oils. The resistance to aggressive media should be individually tested for your application. Further details on request.

[Link to Product](#)**Illustration**

Product may differ from Image

Approvals

The information in this brochure has been compiled with the utmost care.

Liability for the correctness completeness and topicality of the information is restricted to gross negligence. Version: 03/19

Murrelektronik GmbH | Falkenstraße 3 | 71570 Oppenweiler | Fon +49 (71 91) 47-0 | Fax +49 (71 91) 47-491000 | shop@murrelektronik.com | shop.murrelektronik.com



Cables

Cable number	404
No./diameter of wires	16×0.34 + 5×0.75 mm ²
Wire isolation	PVC
C-track properties	1.5 Mio.
Jacket Color	gray
Material (jacket)	PUR/PVC
Material (wire)	Cu wire, bare
Resistor (core)	max. 57 Ω/km (0.34 mm ²), max. 26 Ω/km (0.75 mm ²); (20 °C)
Outer Ø	12.5 mm ±5%
Bend radius (fixed)	10 × outer Ø
Bend radius (moving)	12 × outer Ø
Temperature range (fixed)	-30...+80 °C
Temperature range (mobile)	-30...+80 °C

Technical Data

Total current	max. 2 × 8 A
---------------	--------------

General data

Dimensions H × W × D	33×48×68 mm
----------------------	-------------

Commercial data

country of origin	CZ
customs tariff number	85444290
EAN	4048879058100
eClass	27143423
Packaging unit	1