

MVP12, 4XM12, MOSA, PLUGGABLE CABLE

5.0m PUR-JB 8x0,34+5x0,75

4-way, 5-pole, MOSA

PUR/PVC (UL/CSA)

5.0 m

potentially separated

with LED for digital PNP-signals 24 V DC

[Link to Product](#)

Illustration

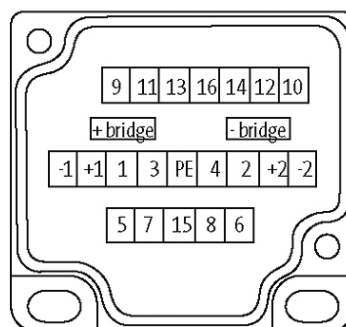
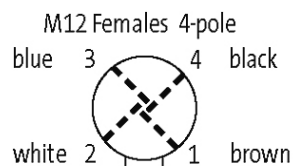

for 2 signals per port

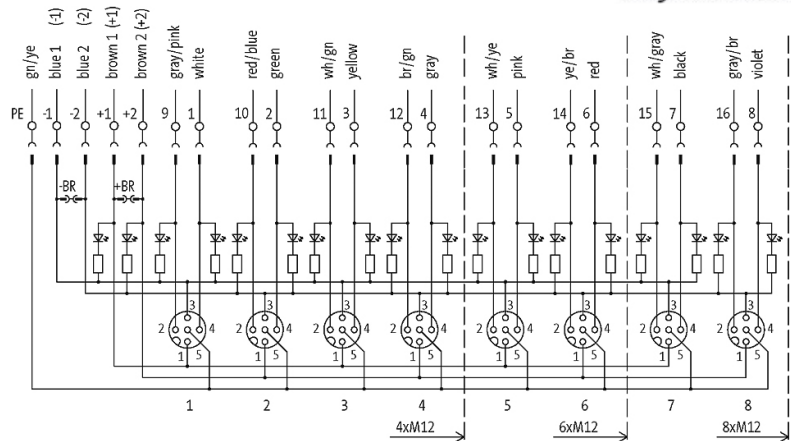

Product may differ from Image

Contact Layout

PIN 1	(+)
PIN 2	(NC)/(S2)
PIN 3	(-)
PIN 4	(NO)/(S1)
PIN 5	(Earth)
LED display	LED (green): Power / LED (yellow): (S1/S2)

Cables

Cable number	374
No./diameter of wires	8×0.34 + 5×0.75 mm ²
Wire isolation	PVC
C-track properties	1.5 Mio.
Jacket Color	gray
Material (jacket)	PUR/PVC
Outer Ø	9.2 mm ±5%
Bend radius (fixed)	10 × outer Ø
Bend radius (moving)	12 × outer Ø
Temperature range (fixed)	-30...+80 °C
Temperature range (mobile)	-30...+80 °C
Color (jacket)	gray

Technical Data

Operating voltage	24 V DC
Operating current per contact	max. 4 A
Total current	max. 2 × 8 A
Signal per port	2
Connection cross section	0.25...0.5 mm ²
Housing	Plastic, flame retardant
Protection	IP67 inserted and tightened (EN 60529)
Locking of ports	Cap nut

General data

Temperature range	-20...+80 °C
Dimensions H x W x D	43x50.2x122 mm

Commercial data

country of origin	DE
customs tariff number	85444290
EAN	4048879057639
eClass	27279219
Packaging unit	1