

IO-Link / analog converter

AI I 4 ... 20mA, M12, straight

IOL AI-I-STR-4...20 mA-UNI
IO-Link V1.1

Connection cables are in the online shop under "Connection Technology".

[Link to Product](#)

Illustration



Male

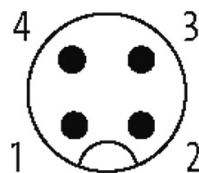

PIN 1: +24 V (L+)
PIN 2: n.c.
PIN 3: GND
PIN 4: C/Q, IO-Link

Female

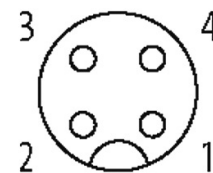

PIN 1: +Us
PIN 2: A+
PIN 3: GND (Analog Us)
PIN 4: A-

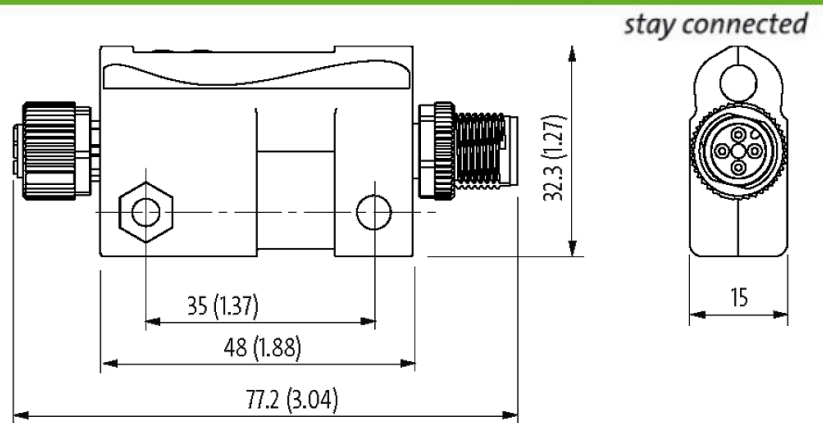

Product may differ from Image

Approvals



More Info



Input

Sensor supply US	24 V DC (EN 61131-2), max. 200 mA
Input range (analog)	4...20 mA
Valency	348 nA
Input resistor (analog)	232 Ω
Resolution (analog)	15 Bit + sign
Accuracy	0.10% (25 °C)
Temperature drift	45 ppm/°K
Conversion time (analog)	max. 5 ms
Input filter	yes, mean value formation, parameterizable N = 0...64
Invers-polarity protection	yes, permanently
Over voltage protection	30 V DC

Connections

IO-Link	M12 (male) 5-pole, A-coded
Analog input	M12 (female) 5-pole, A-coded, shielded

Module supply

Operating voltage	24 V DC (18...30 V DC)
Current consumption	max. 19 mA

General data

Protection	IP65/IP67
------------	-----------

Material (housing)	Plastic
Labeling	Laser labelled
Temperature range	-30...+70 °C (storage temperature -40...+85 °C)
Dimensions H × W × D	32.3×77.2×15 mm

IO-Link

Specification	IO-Link V1.1
Operating modes	COM2 (38.4 kBit/s)
Port Class	A
Cycle time	min. 2.3 ms
Data width	16 Bit / 2 Byte
Data format	Siemens S7

Parameterization

Measured value	preset
Diagnostics	lower limit, upper limit, over heated, supply over voltage, supply under voltage, defective device, sensor supply over current, overrun
lower limit	2 Byte
upper limit	2 Byte
Mean value filter	1 Byte

Protection

Reverse polarity protection module	yes, permanently
Short-circuit protection sensor	yes, permanently
feed back resistance	yes, permanently
Over voltage protection	30 V DC

Diagnostic

Communication status	via LED and IO-Link
Diagnostic via LED	yes
Diagnostic via IO-Link	yes
Monitoring - limit	yes
Monitoring - temperature	yes
Monitoring - over voltage	yes
Monitoring - under voltage	yes
Short-circuit and overload	yes
Underride and overrun	yes

Commercial data

country of origin	DE
customs tariff number	85389099
EAN	4048879622226
eClass	27242601
Packaging unit	1