

UFL 20 L PLUG FOR SIGNAL TRANSFER

24 VDC / 1 A - male with LED

Ribbon cable connector + LED
20-pole

Via the combined fixing mechanism, connectors with or without strain relief can be connected.

[Link to Product](#)

Illustration

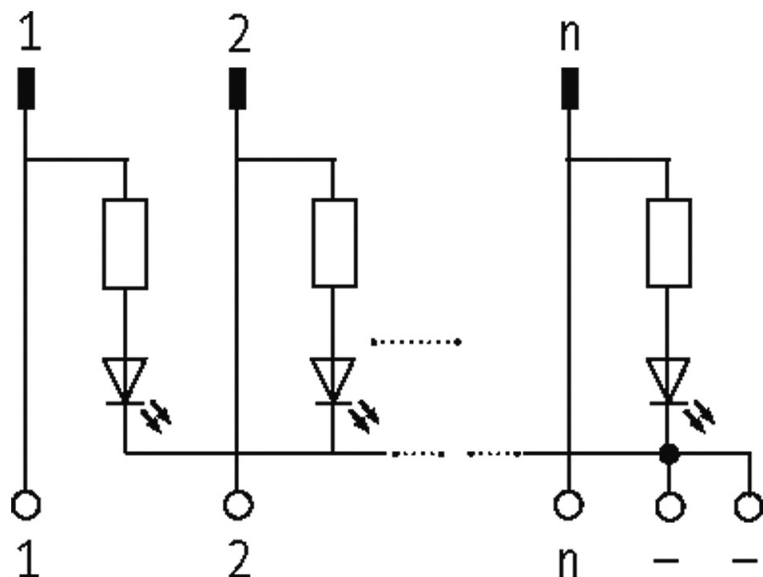
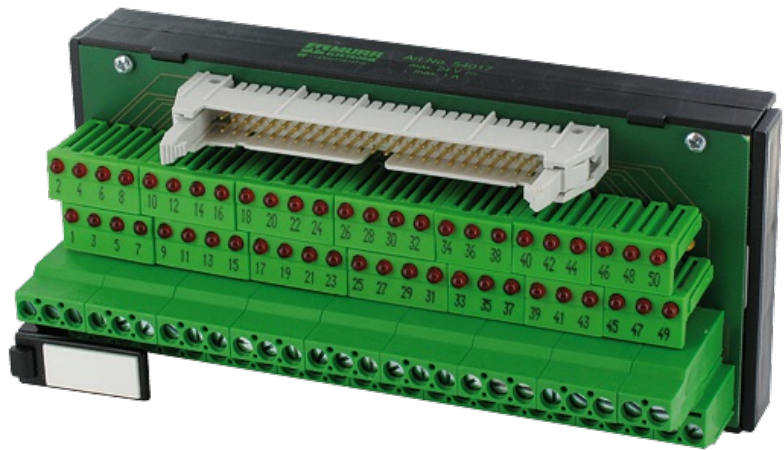

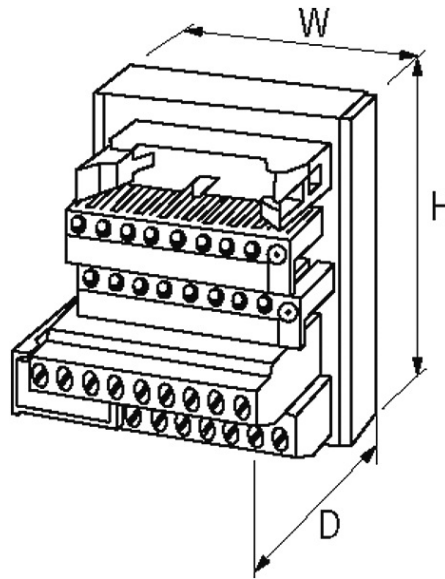

Product may differ from Image

Technical Data

Operating voltage	24 V AC
Operating current per bit	max. 1 A
LED display	LED (red) Ø 3 mm per pole, acc. to potential -
Material group	EN 60664-1 over voltage, category II
Plug connector	for plugs with or without strain relief (DIN 41651); for plugs with strain relief, it may be necessary to remove the bottom hook

General data

Mounting method	DIN-rail mountable (EN 60715)
Temperature range	-20...+70 °C
Dimensions H x W x D	63x75x48 mm

Commercial data

country of origin	CZ
customs tariff number	85366990
EAN	4048879026604
eClass	27141120
Packaging unit	1