

## UG SUB 15 SL FOR SIGNAL TRANSFER (LED)

Product discontinued

Male connector + LED  
15-pole  
Screw terminals

### [Link to Product](#)

#### Illustration

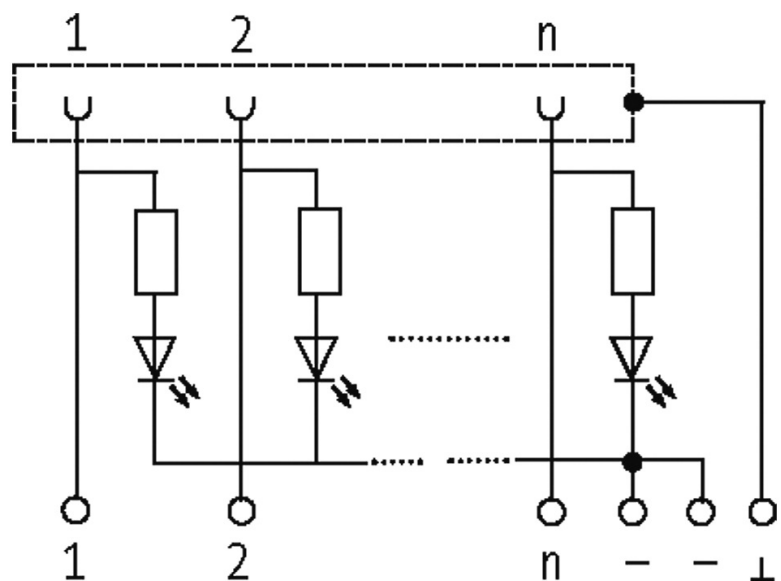

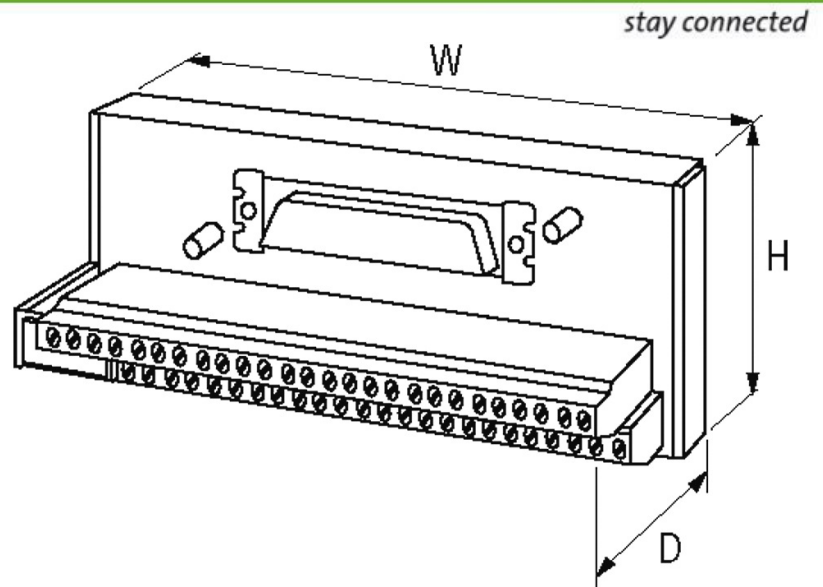

Product may differ from Image

### Technical Data

Operating voltage	24 V DC $\pm$ 15%
Operating current per bit	max. 2 A
LED display	LED (red) $\varnothing$ 3 mm per pole, acc. to potential -
Material group	EN 60664-1 over voltage, category II
Locking of ports	Standard UNC 4-40 screw thread bolt (EN 60807)

### General data

Mounting method	DIN-rail mountable (EN 60715)
Temperature range	-20...+70 °C
Dimensions H x W x D	75x70x66 mm

### Commercial data

country of origin	CZ
customs tariff number	85366990
EAN	4048879026437
eClass	27143424
Packaging unit	1