

UG SUB 9 BL FOR SIGNAL TRANSFER (LED)

Product discontinued

Female connector + LED
9-pole
Screw terminals
with LED

[Link to Product](#)

Illustration

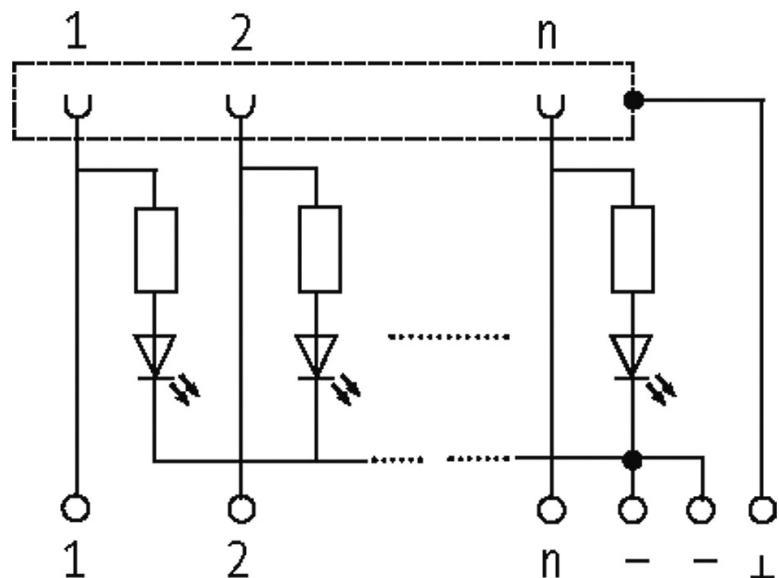

stay connected

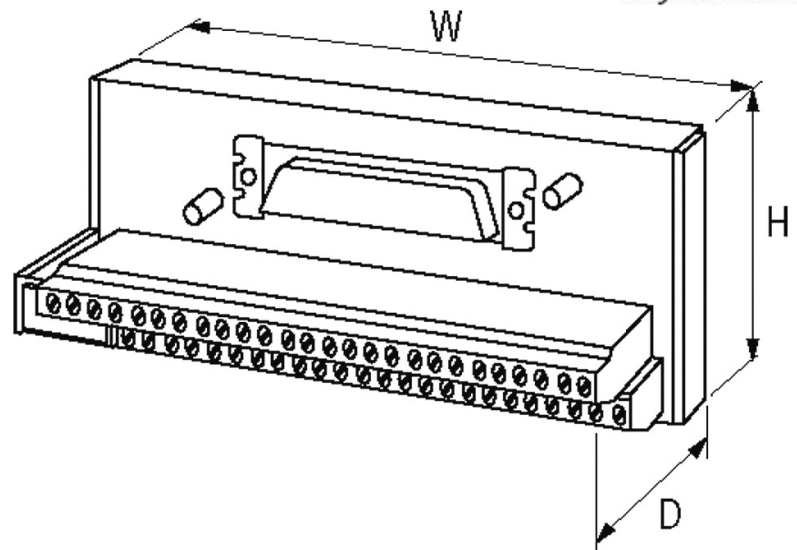

Product may differ from Image

Technical Data

Operating voltage	24 V DC \pm 15%
Operating current per bit	max. 2 A
LED display	LED (red) \varnothing 3 mm per pole, acc. to potential -
Material group	EN 60664-1 over voltage, category II
Locking of ports	Standard UNC 4-40 screw thread bolt (EN 60807)

General data

Mounting method	DIN-rail mountable (EN 60715)
Temperature range	-20...+70 °C
Dimensions H x W x D	75x45x66 mm

Commercial data

country of origin	CZ
customs tariff number	85369010
EAN	4048879026390
eClass	27143424
Packaging unit	1