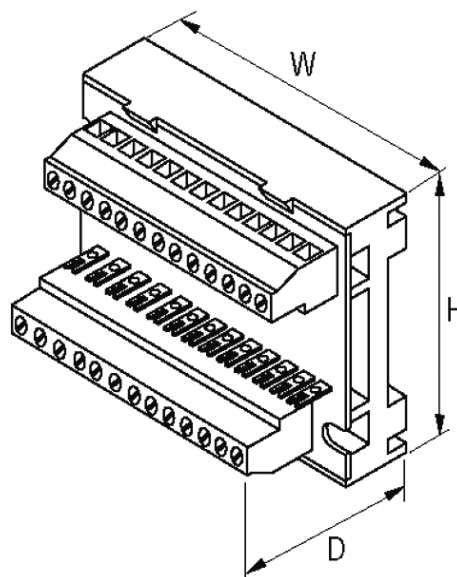

ASSEMBLY MODULE MP 12

Mounting rail / screw-type terminal

12 pairs of solder pins

screw terminals connected to solder pin pairs

[Link to Product](#)**Illustration**

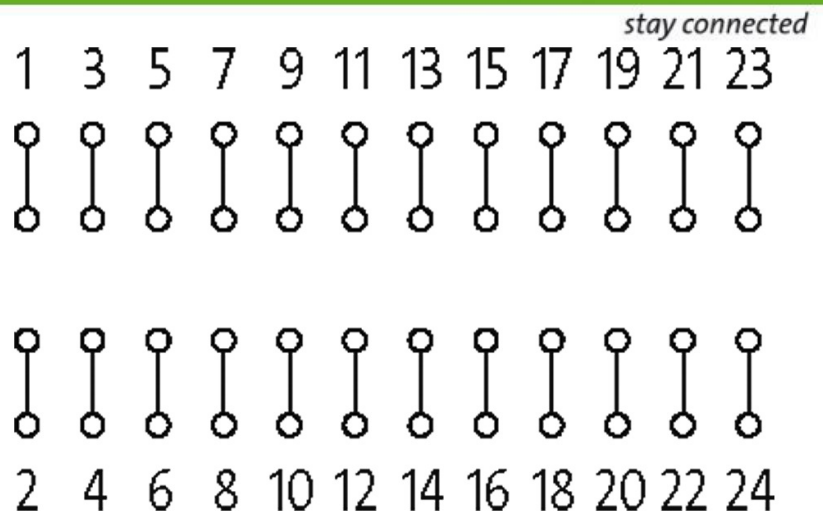

Product may differ from Image

Technical Data

Operating voltage	max. 250 V AC/DC
Operating current	max. 5 A
Distance of solder pins	24 mm

General data

Connection	Screw terminals: max. 4 mm ² , pairs of solder pins (spacing 5 mm)
Mounting method	DIN-rail mountable TH35 or G32 (EN 60715) or screwable
Housing	Plastic, flame retardant. Open design.
Dimensions H × W × D	63×70×36 mm
Temperature range	-20...+60 °C

Commercial data

country of origin	CZ
customs tariff number	85369010
EAN	4048879042253
eClass	27260710
Packaging unit	1