

SV-SUB D 9ST.-KL FK

Male connector
9-pole
Spring clamp terminals

[Link to Product](#)**Illustration**

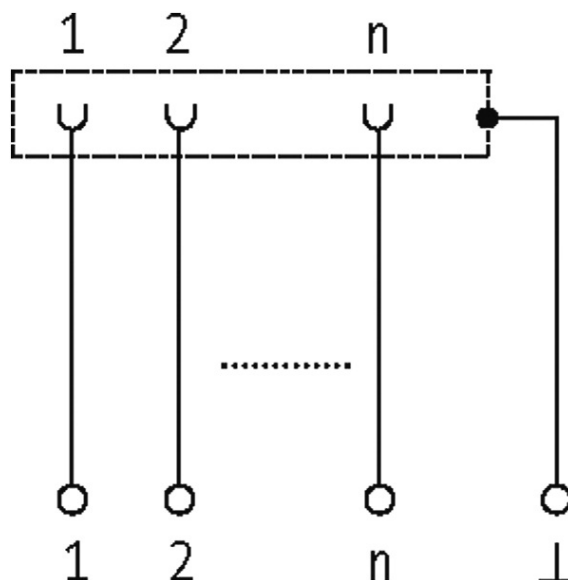
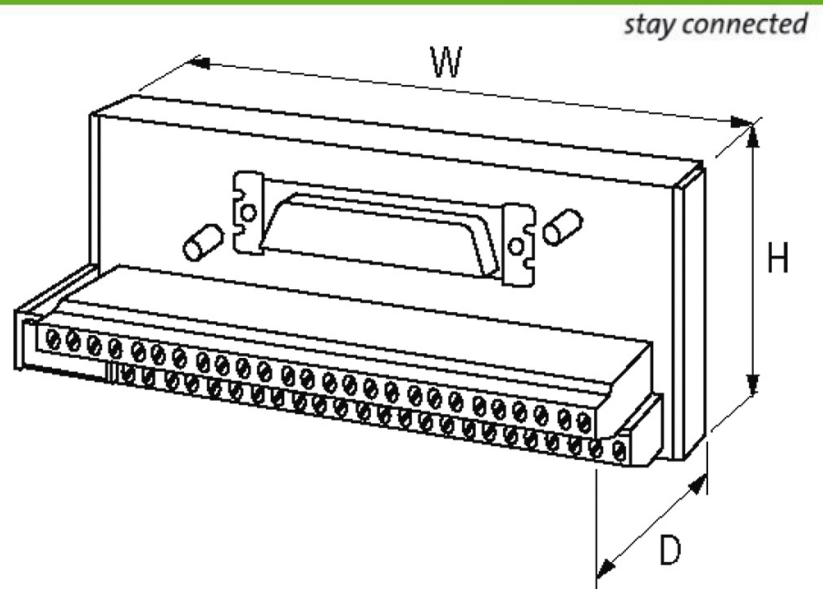

Product may differ from Image

Technical Data

Operating voltage	125 V AC/150 V DC
Operating current per bit	max. 2 A
Material group	EN 60664-1 over voltage, category II
Locking of ports	Standard UNC 4-40 screw thread bolt (EN 60807)

General data

Mounting method	DIN-rail mountable (EN 60715)
Temperature range	-20...+70 °C
Dimensions H x W x D	63x50x48 mm

Commercial data

country of origin	CZ
customs tariff number	85366990
EAN	4048879021623
eClass	27379201
Packaging unit	1