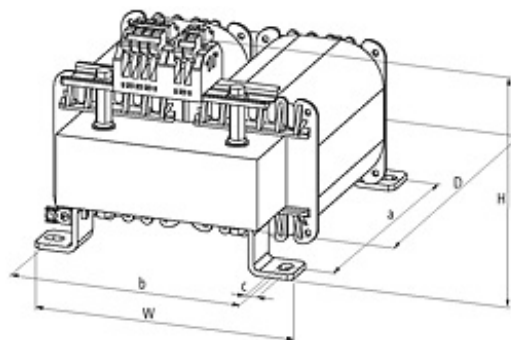
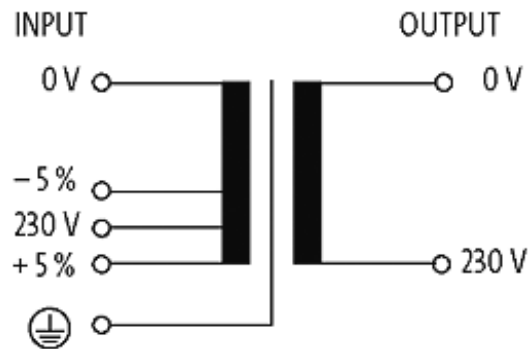

MET 1-PHASE CONTROL AND ISOLATION TRANSFORMER

P: 3000VA IN: 230VAC+/- 5% OUT: 230VAC

Single-phase - Control and Isolation Transformers
3 000 VA
Spring clamp terminals
Isolation class T 40/B

[Link to Product](#)**Illustration**

stay connected

Product may differ from Image

Approvals



Input

Input voltage	230 V AC \pm 5%
Frequency	50...60 Hz
Input current	13.6 A (230 V AC)
Short-circuit current	623.9 A (230 V AC)
Inrush current	209.9 A (230 V AC)

General data

Standards	EN 61558-1, EN 61558-2-4, EN 62041 category 0
Test isolation voltage	4 kV (prim./sec.)
Dimensions H x W x D	195x198x250 mm
Fixing centers a x b x c	200x174x9 mm
Drill hole \varnothing	9x14 mm
Mounting method	Long-hole mounting
Temperature range	-20...+40 °C (storage temperature -40...+80 °C)

Output

Output voltage	230 V AC
Output rating	3 000 VA

Commercial data

country of origin	CZ
customs tariff number	85043200
EAN	4048879066303
eClass	27031302
Packaging unit	1