

MPOT POTENTIOMETER MODULE

Product discontinued, no alternative

10-turn potentiometer
with relay contact
5 k Ω

The 10-turn potentiometer has a decimal scale and locking lever 10 \times 360 $^\circ$ potentiometer for set-point adjustment via relay or can be switched off

[Link to Product](#)

Illustration

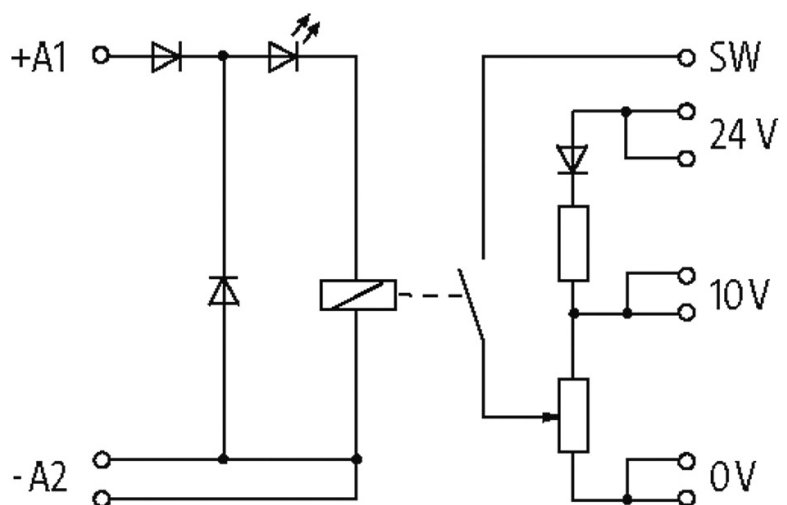

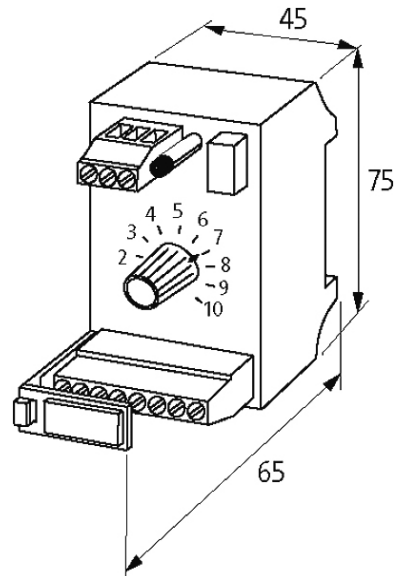

Product may differ from Image

Input

Input voltage	24 V DC
Input current	20 mA
LED display	LED (green)

Technical Data

Resistance tolerance	±5%
Linearity	±0.25%
Power: potentiometer	1.4 W (2 W/40 °C)
Power: resistor	0.25 W

General data

Mounting method	DIN-rail mountable (EN 60715)
Temperature range	0...+60 °C
Dimensions H × W × D	75×45×65 mm

Output

Switching voltage	10 V DC, 24 V DC
Switching current per output	1 mA/1 A
Contact material	PdNi-Au Rh

Description

Functional description	The potentiometer modules are fitted with standard values. They are available as 270° potentiometer and as 10-turn potentiometer with fine adjustment. They can be operated with 10 V DC or 24 V DC. A resistor reduces the voltage so that a 24 V DC voltage c
------------------------	---

Commercial data

country of origin	CZ
customs tariff number	85334010
EAN	4048879041560

eClass	27371227
Packaging unit	1