

**LED-INDICATOR GREEN**

LED 5mm - 24V DC - 15mA - IP40

(green)  
24 V DC  
Protection IP40  
with lamp test input

[Link to Product](#)**Illustration**

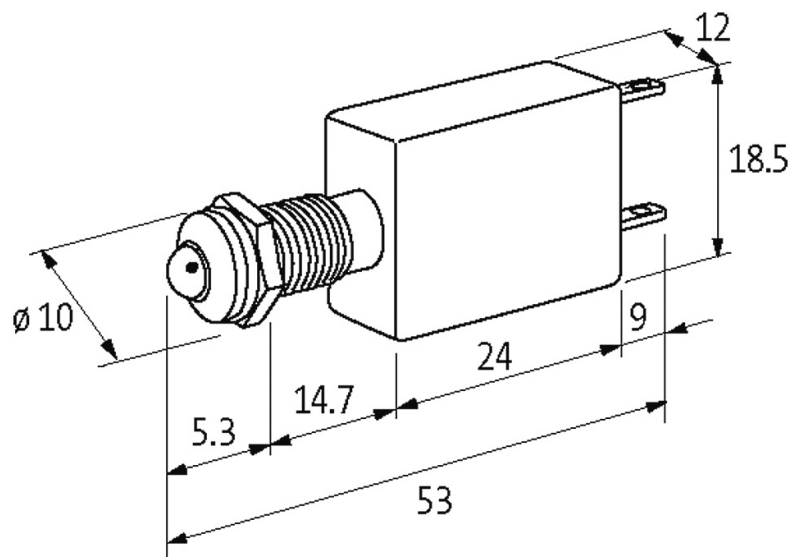
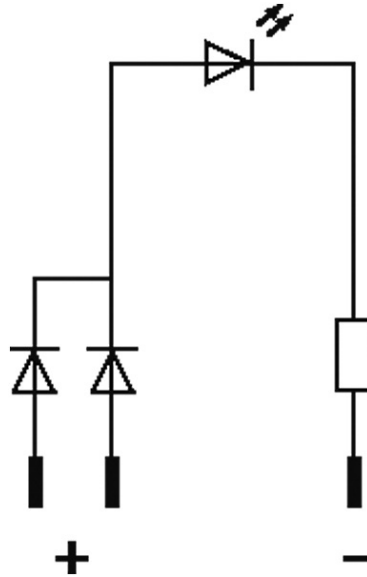

Product may differ from Image

### Technical Data

Operating voltage	24 V AC/DC $\pm 15\%$
Current consumption	15 $\pm 2$ mA
Protection (IEC 60529/EN 60529)	IP40

### General data

Housing	Adapter - PVC, gray
LED $\varnothing$	5 mm
Front panel hole diameter $\varnothing$	8 mm
Dimensions H $\times$ W $\times$ D	18.5 $\times$ 12 $\times$ 53 mm
Connection	Faston 2.8 $\times$ 0.8 mm
Temperature range	-40...+70 °C

### Commercial data

country of origin	DE
customs tariff number	85318070
EAN	4048879040884
eClass	27261590
Packaging unit	10