

LED-INDICATOR RED/GREEN

LED 5mm - 24V DC - 15mA - IP67

(red/green)
24 V DC
Protection IP67

[Link to Product](#)**Illustration**

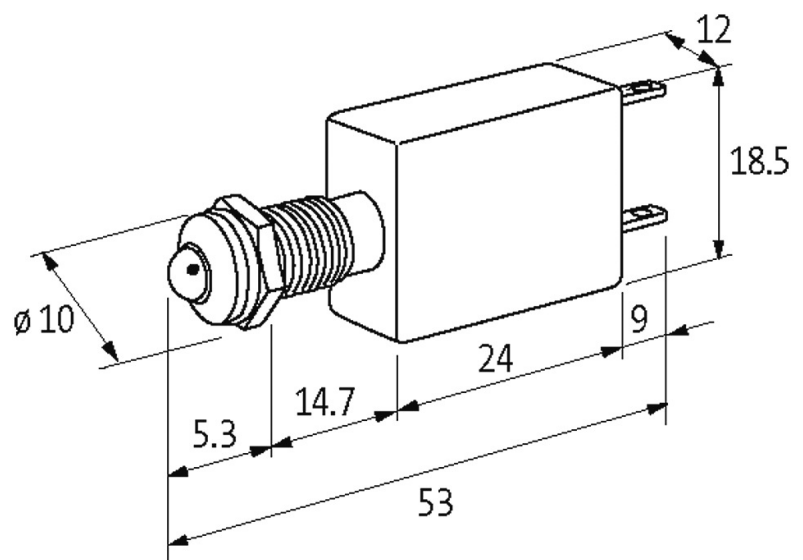
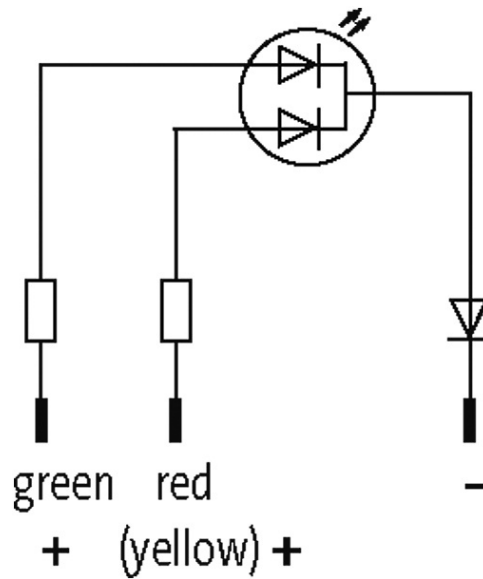

Product may differ from Image

Technical Data

Operating voltage	24 V DC $\pm 15\%$
Current consumption	15 ± 2 mA
Protection (IEC 60529/EN 60529)	IP67

General data

LED \varnothing	5 mm
Front panel hole diameter \varnothing	8 mm
Dimensions H x W x D	18.5x12x53 mm
Connection	Faston 2.8 x 0.8 mm
Housing	Adapter - PVC, gray
Temperature range	-40...+70 °C

Commercial data

country of origin	DE
customs tariff number	85318070
EAN	4048879040563
eClass	27261590
Packaging unit	10