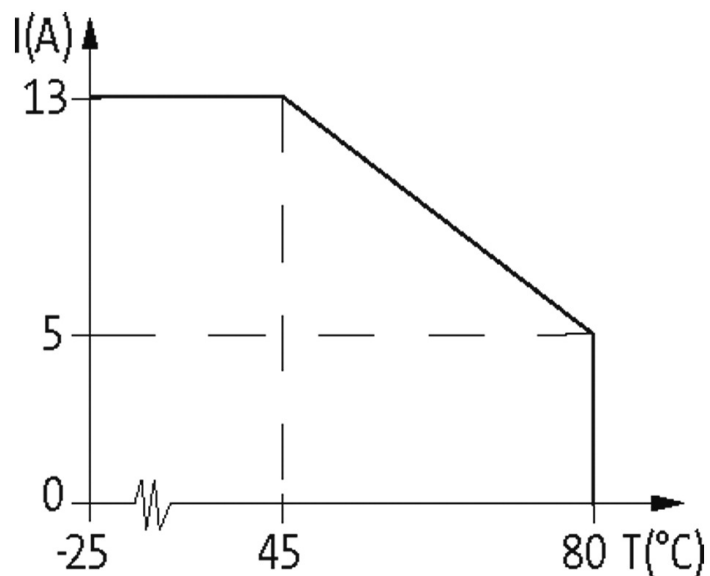

MVP-METALL, 4XM12, 5POLE, PRE-WIRED CABLE

10.0m PUR 8x0,5+3x1,0, UL/CSA

4-way, 5-pole
without LED for analog signals up to 125 V AC/DC
10.0 m
Replaces identical product (Art.No. 27478)

Further cable lengths on request.

[Link to Product](#)**Illustration**

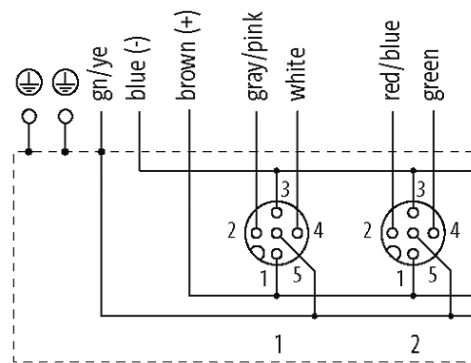
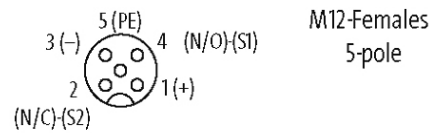
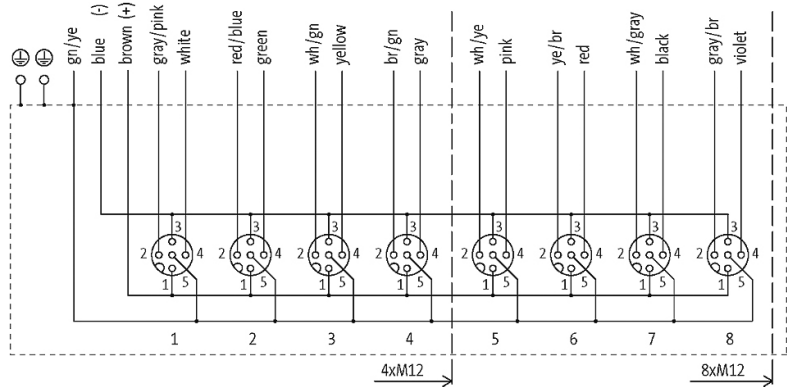
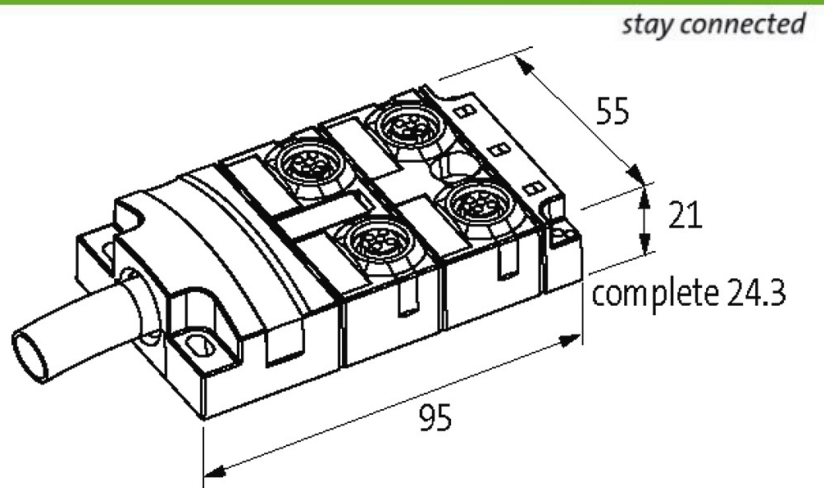

for 2 signals per port

Product may differ from Image

Approvals

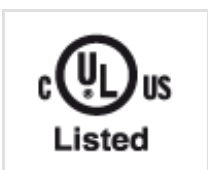

Contact Layout

PIN 1	(+)
PIN 2	(NC)/(S2)
PIN 3	(-)
PIN 4	(NO)/(S1)
PIN 5	(Earth)

Cables

Cable number	448
No./diameter of wires	8×0.5 + 3×1.0 mm ²
Wire isolation	T PE (grpk, wh, rdbl, gn, whgn, ye, brgn, gr, br, bl, gnye)
C-track properties	5 Mio.
Jacket Color	gray
Material (jacket)	PUR (UL/CSA)
Outer Ø	9.1 mm ±5%
Bend radius (moving)	10 × outer Ø
Temperature range (fixed)	-40...+90 °C
Temperature range (mobile)	-40...+90 °C
Material (wire)	Cu wire, bare
Bend radius (fixed)	5 × outer Ø
Approval (cable)	UL (AWM-Style 20233), CSA

Technical Data

Operating voltage	max. 125 V AC/DC
Operating current per contact	max. 4 A
Total current	max. 7.5 A
Locking of ports	Screw thread M12 × 1 mm
Protection	IP65, IP67, IP68
Housing	Zinc die casting, matte nickel plated

General data

Temperature range	-20...+90 °C, depending on cable quality
-------------------	--

Commercial data

country of origin	CZ
customs tariff number	85444290
EAN	4048879350938
eClass	27279219
Packaging unit	1