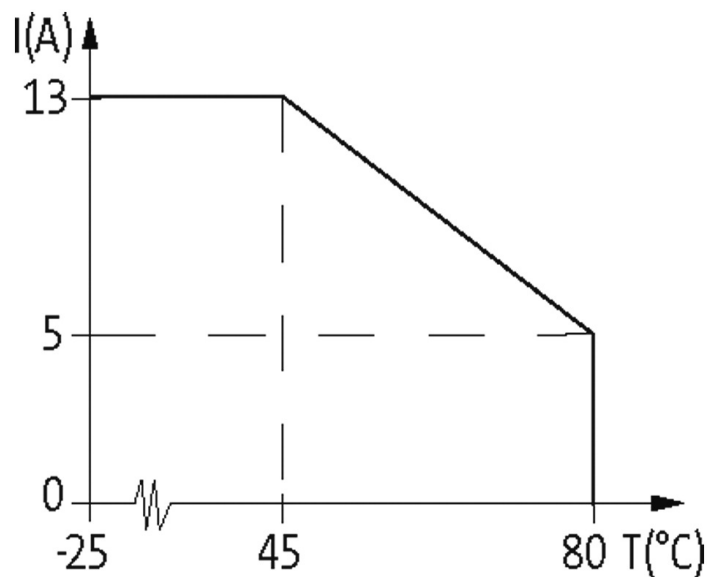

MVP-METALL, 4XM12, 5POLE, PRE-WIRED CABLE

5.0m PUR 8x0,34+3X0.75, UL/CSA

4-way, 5-pole
shielded
with LED for digital PNP-signals 24 V DC
5.0 m
Replaces identical product (Art.No. 27482)

Further cable lengths on request.

[Link to Product](#)**Illustration**

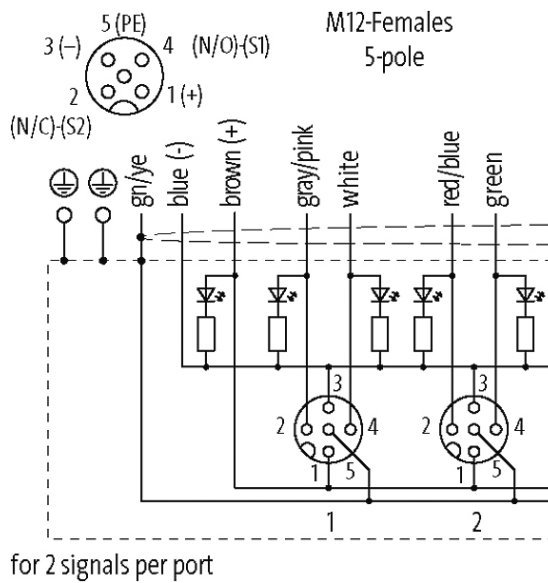
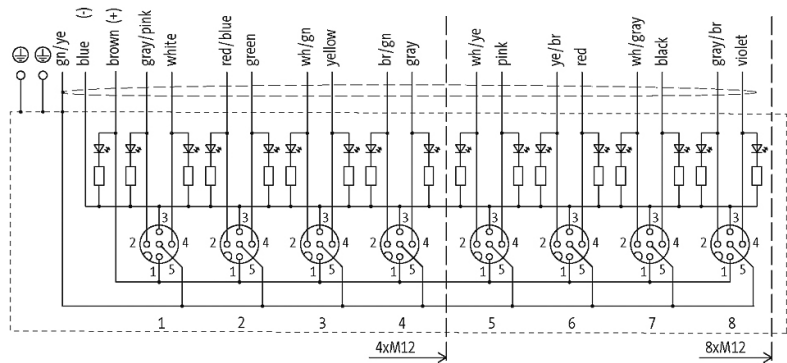
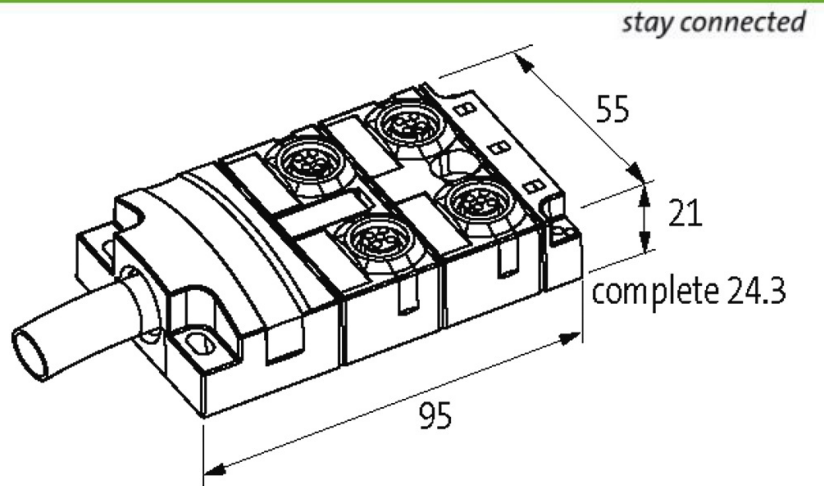

Product may differ from Image

Approvals



Contact Layout

PIN 1	(+)
PIN 2	(NC)/(S2)
PIN 3	(-)
PIN 4	(NO)/(S1)
PIN 5	(Earth)
LED display	LED (green): Power / LED (yellow): (S1/S2)
Shield	via M12 thread

Cables

Cable number	373
No./diameter of wires	8×0.34 + 3×0.75 mm ²
Wire isolation	TPE (grpk, wh, rdbl, gn, whgn, ye, brgn, gr, br, bl, gnye)
C-track properties	5 Mio.
Jacket Color	gray
Material (jacket)	PUR (UL/CSA)
Outer Ø	9.3 mm ±5%
Bend radius (fixed)	10 × outer Ø
Bend radius (moving)	12 × outer Ø
Temperature range (fixed)	-40...+90 °C
Temperature range (mobile)	-40...+90 °C
Shield	yes
Color (jacket)	gray

Technical Data

Operating voltage	24 V DC
Operating current per contact	max. 4 A
Total current	max. 7.5 A
Locking of ports	Screw thread M12 × 1 mm
Protection	IP65, IP67, IP68
Housing	Zinc die casting, matte nickel plated

General data

Temperature range	-20...+90 °C, depending on cable quality
-------------------	--

Commercial data

country of origin	CZ
customs tariff number	85444290
EAN	4048879351089
eClass	27279219
Packaging unit	1