

**MVP-METALL, 4XM12, 5POLE, PRE-WIRED CABLE**

15.0m PUR 8x0,34+3X0.75, UL/CSA

4-way, 5-pole

shielded

without LED, 5-pole (for analog signals)

15.0 m

Replaces identical product (Art.No. 27489)

Further cable lengths on request.

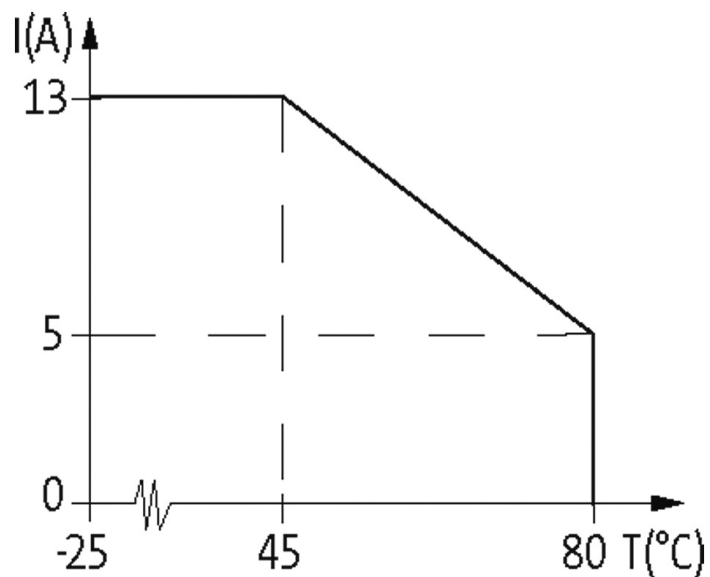
[Link to Product](#)**Illustration**

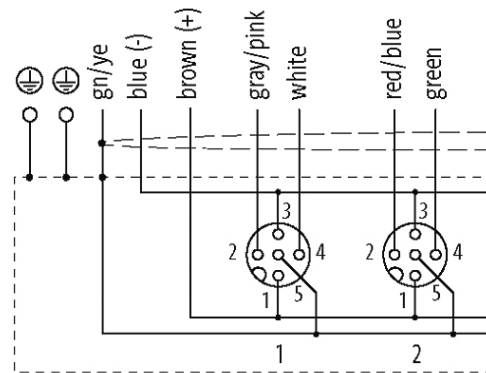
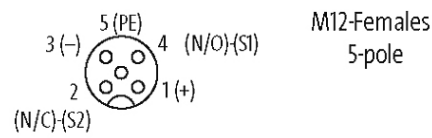
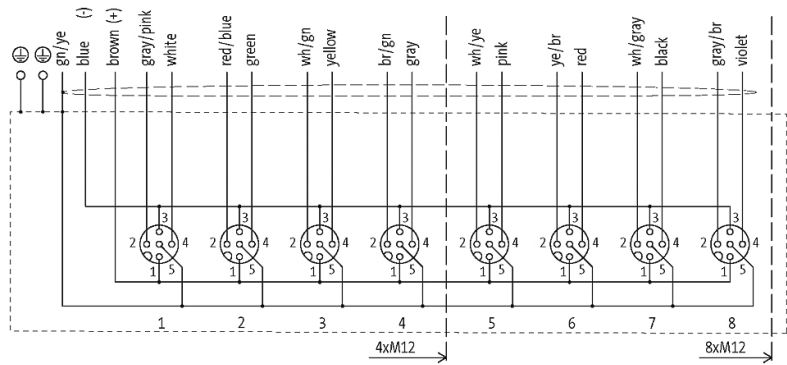
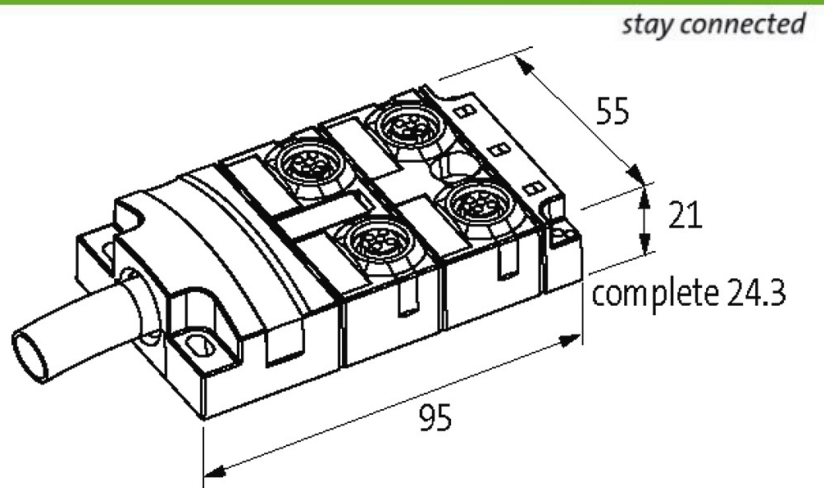

for 2 signals per port

Product may differ from Image

**Approvals**



**Contact Layout**

PIN 1	(+)
PIN 2	(NC)/(S2)
PIN 3	(-)
PIN 4	(NO)/(S1)
PIN 5	(Earth)
Shield	via M12 thread

### Cables

Cable number	373
No./diameter of wires	8×0.34 + 3×0.75 mm <sup>2</sup>
Wire isolation	TPE (grpk, wh, rdbl, gn, whgn, ye, brgn, gr, br, bl, gnye)
C-track properties	5 Mio.
Jacket Color	gray
Material (jacket)	PUR (UL/CSA)
Outer Ø	9.3 mm ±5%
Bend radius (fixed)	10 × outer Ø
Bend radius (moving)	12 × outer Ø
Temperature range (fixed)	-40...+90 °C
Temperature range (mobile)	-40...+90 °C
Shield	yes
Color (jacket)	gray

### Technical Data

Operating voltage	max. 125 V AC/DC
Operating current per contact	max. 4 A
Total current	max. 7.5 A
Locking of ports	Screw thread M12 × 1 mm
Protection	IP65, IP67, IP68
Housing	Zinc die casting, matte nickel plated

### General data

Temperature range	-20...+90 °C, depending on cable quality
-------------------	--

### Commercial data

country of origin	CZ
customs tariff number	85444290
EAN	4048879351744
eClass	27279219
Packaging unit	1