

MVP-METALL, 4XM12, 5POLE, M23 19POL. CON.

Connector exit frontside

4-way, 5-pole

M23 plug connection, 19-pole

without LED for analog signals up to 125 V AC/DC

Replaces identical product (Art.No. 27531)

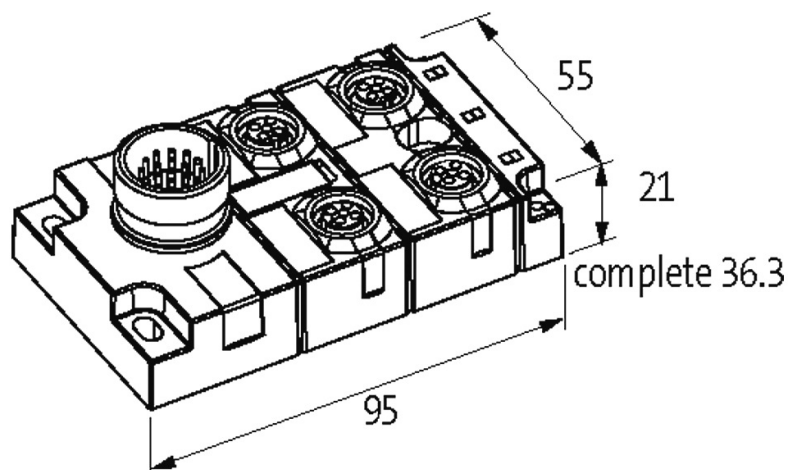
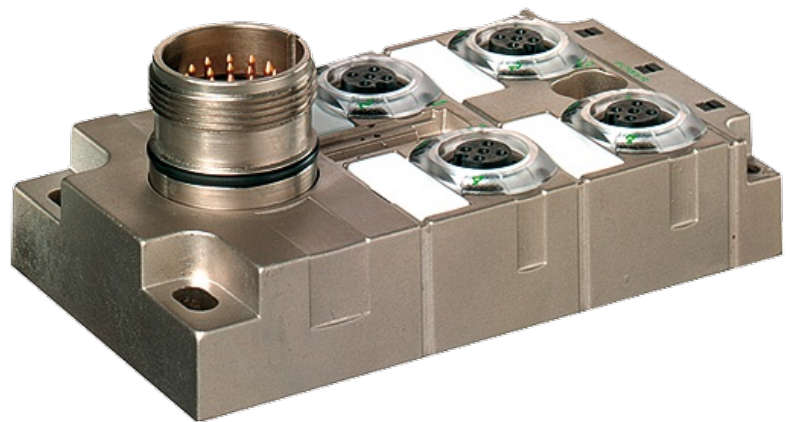
[Link to Product](#)**Illustration**

M12-Females 5-pole

M23-Plug 19-pole

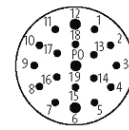
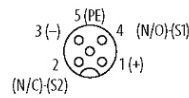

M23-Plug

19-pole

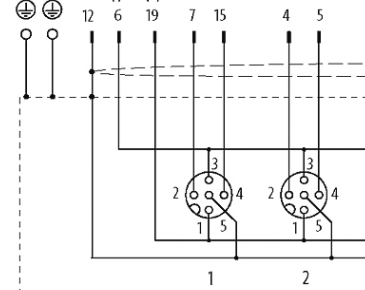

for 2 signals per port

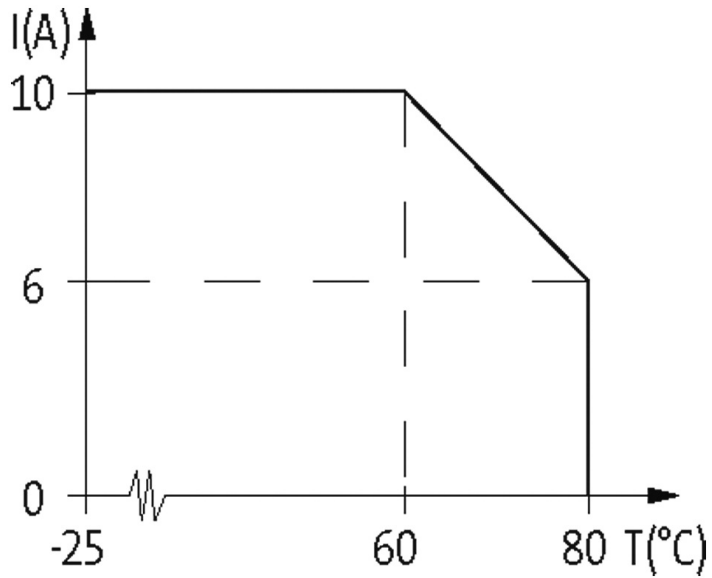

M23-Plug

19-pole

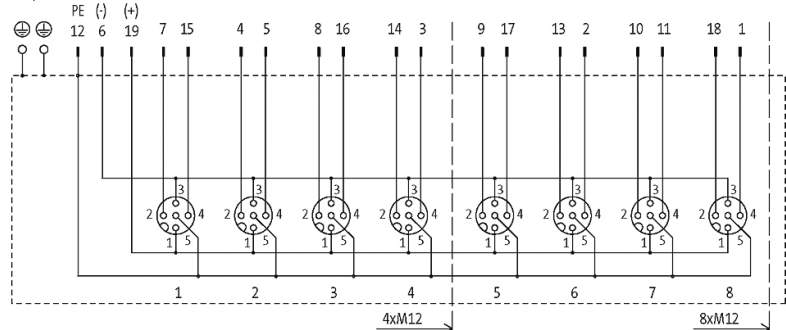

Product may differ from Image

Approvals



Contact Layout

PIN 1	(+)
PIN 2	(NC)/(S2)
PIN 3	(-)
PIN 4	(NO)/(S1)
PIN 5	(Earth)
Shield	via M12 outer thread and M23 outer thread

Technical Data

Operating voltage	max. 125 V AC/DC
Operating current per contact	max. 4 A
Total current	max. 7.5 A
Protection	IP65, IP67, IP68
Housing	Zinc die casting, matte nickel plated

General data

Temperature range	-25...+80 °C
-------------------	--------------

Commercial data

country of origin	CZ
customs tariff number	85369010
EAN	4048879352864
eClass	27279219
Packaging unit	1