

MVP-METALL, 8XM12, 5POLE, PRE-WIRED CABLE

15.0m PUR 16x0,34+3X0.75, UL/CSA

8-way, 5-pole

shielded

without LED for analog signals up to 125 V AC/DC

15.0 m

Replaces identical product (Art.No. 27519)

Further cable lengths on request.

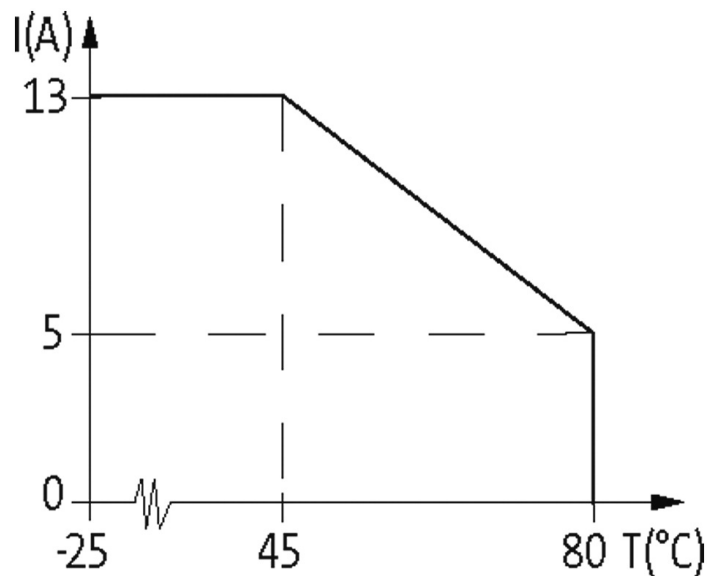
[Link to Product](#)**Illustration**

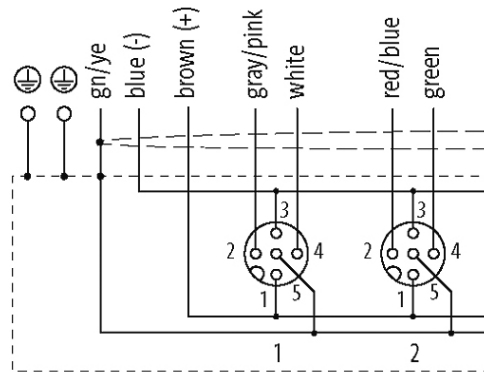
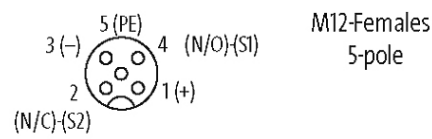
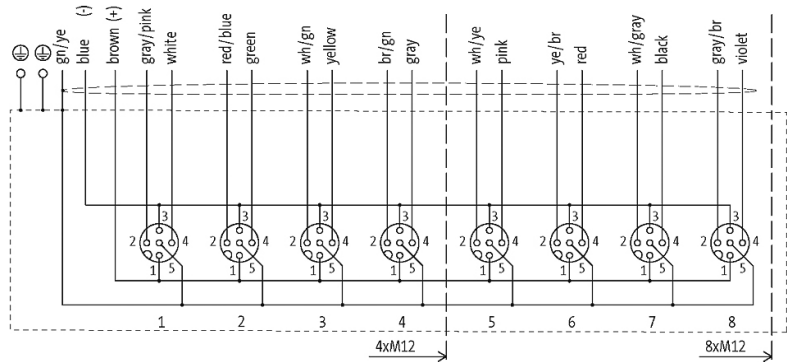
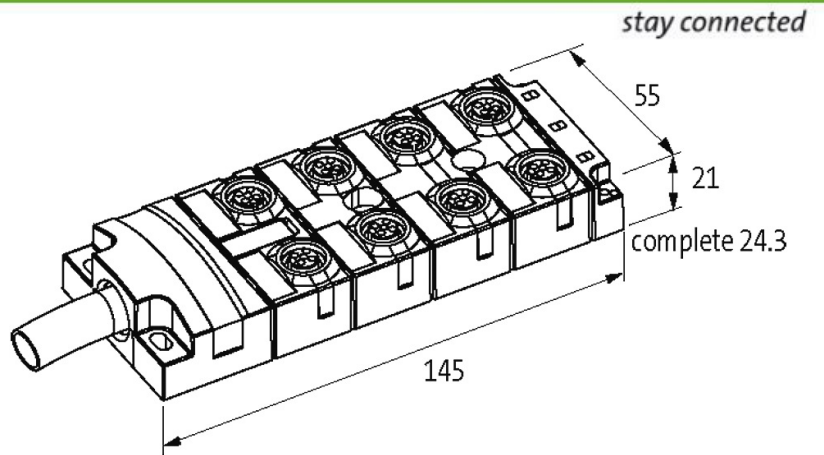

for 2 signals per port

Product may differ from Image

Approvals

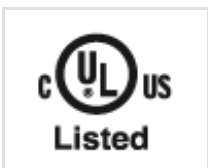

Contact Layout

PIN 1 (+)

PIN 2	(NC)/(S2)
PIN 3	(-)
PIN 4	(NO)/(S1)
PIN 5	(Earth)
Shield	via M12 thread

Cables

Cable number	401
No./diameter of wires	16×0.34 + 3×0.75 mm ²
Wire isolation	T PE (grpk, wh, rdbl, gn, whgn, ye, brgn, gr, whye, pk, yebr, rd, whgr, bk, grbr, vi, br, bl, gnye)
C-track properties	5 Mio.
Jacket Color	gray
Material (jacket)	PUR (UL/CSA)
Outer Ø	11.7 mm ±5%
Bend radius (moving)	12 × outer Ø
Temperature range (fixed)	-40...+90 °C
Temperature range (mobile)	-40...+90 °C
Cable identification	401
Approval (cable)	UL (AWM-Style 20233/10042), CSA; CE conform
Cable weight [g/m]	237,6
Material (wire)	Cu wire, bare
Resistor (core)	max. 53 Ω/km (0.34 mm ²); max. 26 Ω/km (0.75 mm ²); (20 °C)
Single wire Ø (core)	0.1 mm
Diameter (core)	16×0.34 + 3×0.75 mm ²
AWG	similar to AWG 22 (0.34 mm ²); similar to AWG 18 (0.75 mm ²)
Material (wire isolation)	T PE-E
Shore hardness (wire isolation)	55 ±5 D
Wire-Ø incl. isolation	1.3 ±5% mm (0.34 mm ²); 2.6 ±5% (0.75 mm ²)
Color/numbering of wires	grpk, wh, rdbl, gn, whgn, ye, brgn, gr, whye, pk, yebr, rd, whgr, bk, grbr, vi, br, bl, gnye
Shield	yes
	min. 80%
Material (jacket)	PUR
Shore hardness (jacket)	94 ±5 A
Outer-Ø (jacket)	11.7 mm ±5%
Color (jacket)	gray
chemical resistance	good resistance to oil, gasoline and chemicals (ISO 6722)
Nominal voltage	300/300 V AC
Test voltage	2 000 V AC
Current load capacity	to DIN VDE 0298-4
Temperature range (fixed)	-40...+90 °C
Temperature range (mobile)	-40...+90 °C

Bend radius (fixed)	10 × outer Ø
Bend radius (moving)	12 × outer Ø
No. of bending cycles (C-track)	max. 5 Mio. (25 °C)
Travel speed (C-track)	max. 2 m/s

Technical Data

Operating voltage	max. 125 V AC/DC
Operating current per contact	max. 4 A
Total current	max. 7.5 A
Locking of ports	Screw thread M12 × 1 mm
Protection	IP65, IP67, IP68
Housing	Zinc die casting, matte nickel plated

General data

Temperature range	-20...+90 °C, depending on cable quality
-------------------	--

Commercial data

country of origin	CZ
customs tariff number	85444290
EAN	4048879352567
eClass	27279219
Packaging unit	1