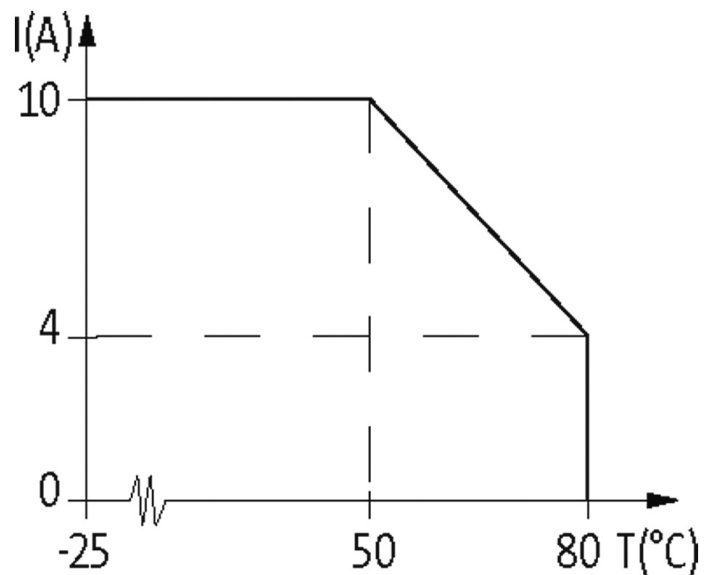

MVP-METALL, 8XM12, 5POLE, PRE-WIRED CABLE

10.0m PUR 16x0,34+5X0.75, UL/CSA

8-way, 5-pole
potentially separated
with LED for digital PNP-signals 24 V DC
10.0 m
Replaces identical product (Art.No. 27523)

Separate protection of ports 1, 3, 5, 7 or 2, 4, 6, 8 possible. Further cable lengths on request.

[Link to Product](#)**Illustration**

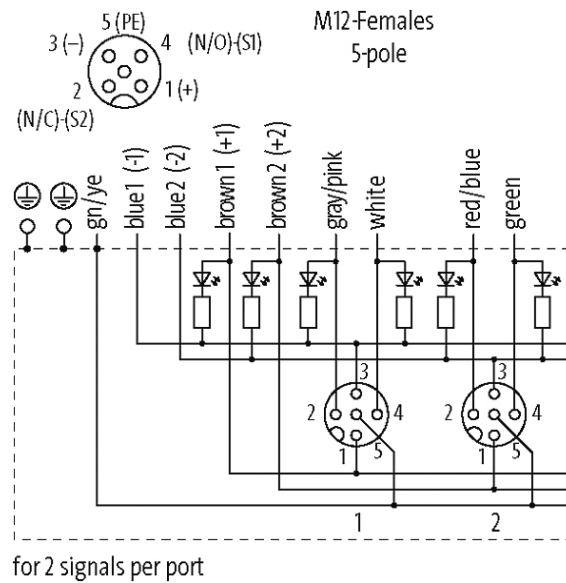
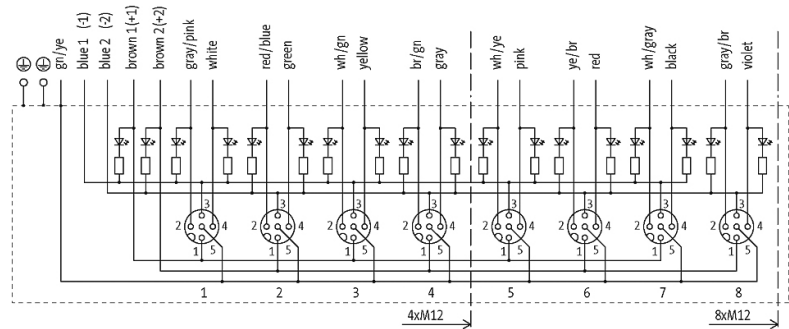
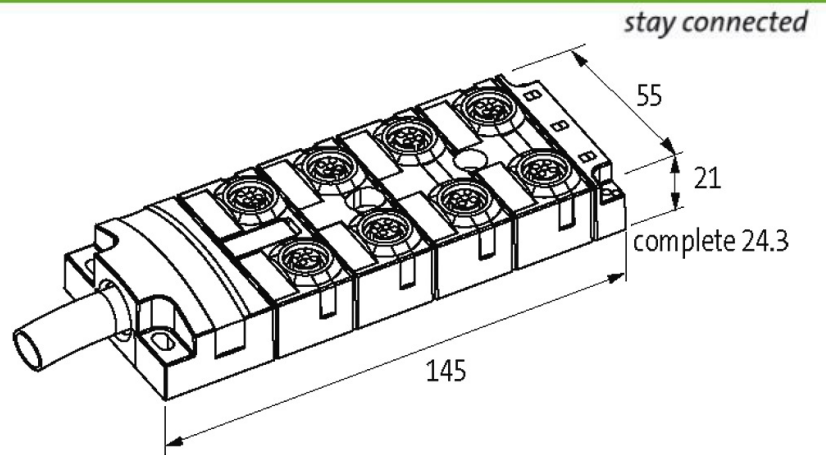

Product may differ from Image

Approvals

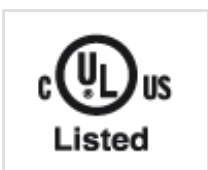

Contact Layout

PIN 1 (+)

PIN 2 (NC)/(S2)

PIN 3	(-)
PIN 4	(NO)/(S1)
PIN 5	(Earth)
LED display	LED (green): Power / LED (yellow): (S1/S2)

Cables

Cable number	403
No./diameter of wires	16×0.34 + 5×0.75 mm ²
Wire isolation	T PE (grpk, wh, rdbl, gn, whgn, ye, brgn, gr, whye, pk, yebr, rd, whgr, bk, grbr, vi, br, bl, gnye)
C-track properties	5 Mio.
Jacket Color	gray
Material (jacket)	PUR (UL/CSA)
Outer Ø	11.5 mm ±5%
Bend radius (moving)	10 × outer Ø
Temperature range (fixed)	-40...+90 °C
Temperature range (mobile)	-25...+80 °C
Approval (cable)	UL (AWM-Style 20233/10042), CSA; CE conform
Material (wire)	Cu wire, bare
Resistor (core)	max. 53 Ω/km (0.34 mm ²); max. 26 Ω/km (0.75 mm ²); (20 °C)
Single wire Ø (core)	0.1 mm
AWG	similar to AWG 22 (0.34 mm ²); similar to AWG 18 (0.75 mm ²)
Material (wire isolation)	T PE-E
Shore hardness (wire isolation)	55 ±5 D
Shield	yes
Shore hardness (jacket)	85 ±5 A
Nominal voltage	300/500 V AC
Test voltage	2 000 V AC
Current load capacity	to DIN VDE 0298-4
Bend radius (fixed)	5 × outer Ø
Bend radius (moving)	10 × outer Ø
No. of bending cycles (C-track)	max. 5 Mio. (25 °C)
Travel speed (C-track)	max. 2 m/s
Acceleration (C-track)	max. 5 m/s ²
Diameter (core)	16×0.34 + 5×0.75 mm ²

Technical Data

Operating voltage	24 V DC
Operating current per contact	max. 4 A
Total current	max. 7.5 A
Locking of ports	Screw thread M12 × 1 mm
Protection	IP65, IP67, IP68
Housing	Zinc die casting, matte nickel plated

General data

Temperature range -20...+90 °C, depending on cable quality

Commercial data

country of origin	CZ
customs tariff number	85444290
EAN	4048879352598
eClass	27279219
Packaging unit	1