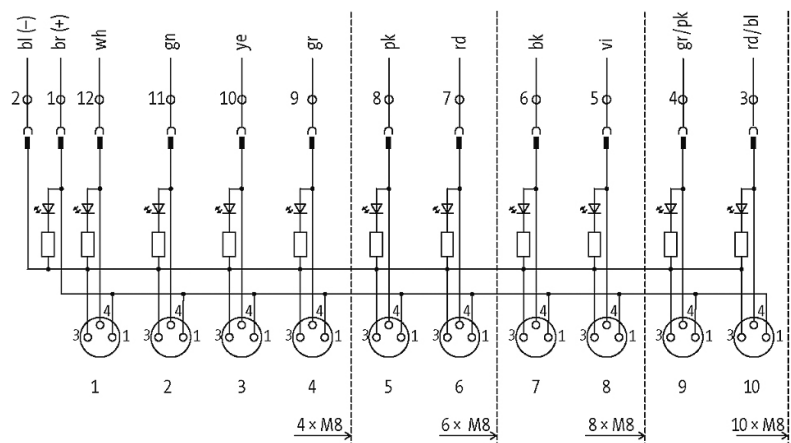
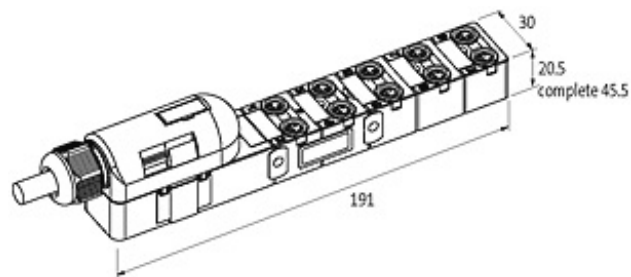

EXACT8, 10XM8, 3 POLE PLUG. CAP, SPRING-TERM.

15.0m PUR 10*0,34+2*0,75 exit norm..

10-way, 3-pole
15.0 m

Further cable lengths on request. Plastic housings with good resistance against chemicals and oils. The resistance to aggressive media should be individually tested for your application. Further details on request.

[Link to Product](#)**Illustration**

M8-Females 3-pole

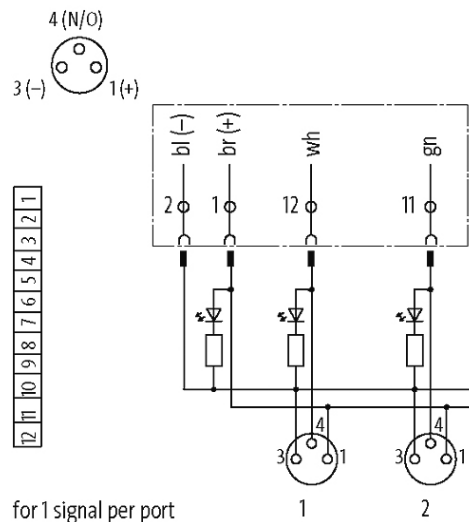

Product may differ from Image

Approvals



Contact Layout

PIN 1	(+)
PIN 3	(-)
PIN 4	(NO)/(S1)
LED display	LED (green): Power / LED (yellow): (S1)

Cables

Cable number	384
No./diameter of wires	10×0.34 + 2×0.75 mm ²
C-track properties	5 Mio.
Jacket Color	gray
Material (jacket)	PUR (UL/CSA)
Outer Ø	9.3 mm ±5%
Bend radius (fixed)	5 × outer Ø
Bend radius (moving)	10 × outer Ø
Temperature range (fixed)	-40...+80 °C
Temperature range (mobile)	-5...+60 °C
Color (jacket)	gray
Approval (cable)	UL (AWM-Style 20233), CSA

Technical Data

Operating voltage	24 V DC
Operating current per contact	max. 2 A

Total current	max. 8 A
Signal per port	1 - (31-32)
Connection	Spring clamp plug-in terminals: max. 1.5 mm ² (AWG 16)
Protection	IP67 inserted and tightened (EN 60529)
Housing	Plastic, flame retardant
Locking of ports	Screw thread M8 × 1 mm

General data

Temperature range	-20...+80 °C, depending on cable quality
-------------------	--

Commercial data

country of origin	CZ
customs tariff number	85444290
EAN	4048879056861
eClass	27279219
Packaging unit	1