

PRE-WIRED CAP FOR EXACT8, 10XM8, 3 POLE

15.0m PUR 10*0,34+2*0,75

for 10-way distribution box, 3-pole
15.0 m

Further cable lengths on request. Plastic housings with good resistance against chemicals and oils. The resistance to aggressive media should be individually tested for your application. Further details on request.

[Link to Product](#)

Illustration



M8-Females 3-pole

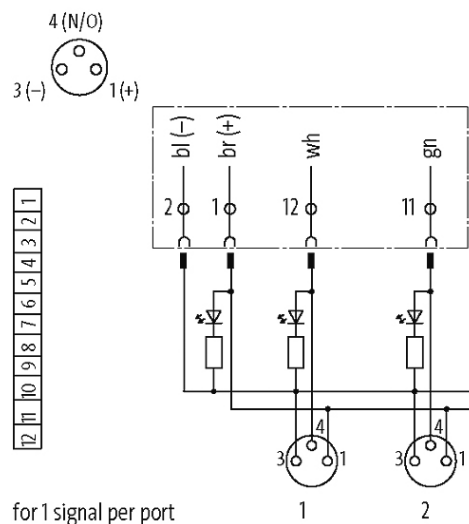

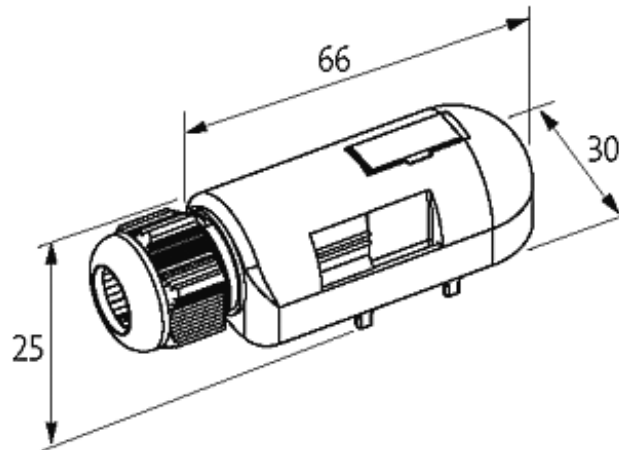

Product may differ from Image

Approvals



Cables

Cable number	384
No./diameter of wires	10×0.34 + 2×0.75 mm ²
C-track properties	5 Mio.
Jacket Color	gray
Material (jacket)	PUR (UL/CSA)
Outer Ø	9.3 mm ±5%
Bend radius (fixed)	5 × outer Ø
Bend radius (moving)	10 × outer Ø
Temperature range (fixed)	-40...+80 °C
Temperature range (mobile)	-5...+60 °C
Color (jacket)	gray
Approval (cable)	UL (AWM-Style 20233), CSA

Technical Data

Total current	max. 8 A
Housing	Plastic, flame retardant

General data

Temperature range	-20...+80 °C, depending on cable quality
-------------------	--

Commercial data

country of origin	CZ
customs tariff number	85444290
EAN	4048879056786
eClass	27143423
Packaging unit	1

