

EXACT8, 10XM8, 4 POLE MOULDED CABLE

10.0m PUR/PVC 20x0,34+2x0,75

10-way, 4-pole
PUR/PVC
10.0 m

Further cable lengths on request. Plastic housings with good resistance against chemicals and oils. The resistance to aggressive media should be individually tested for your application. Further details on request.

[Link to Product](#)

Illustration

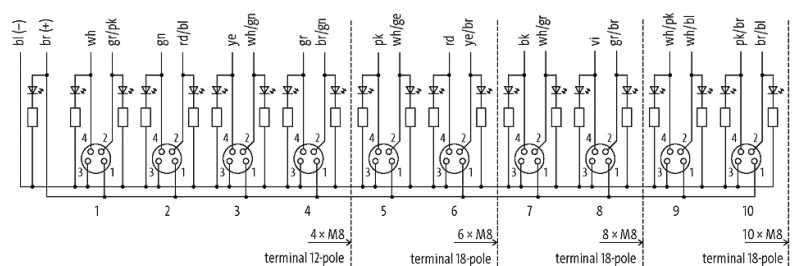
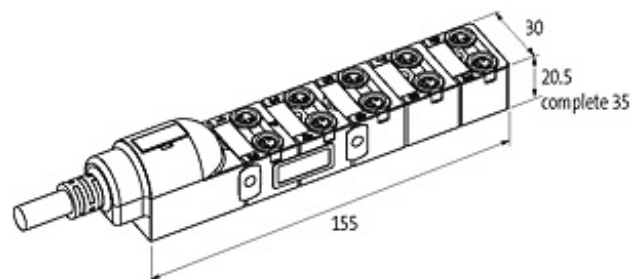

M8-Females 4-pole

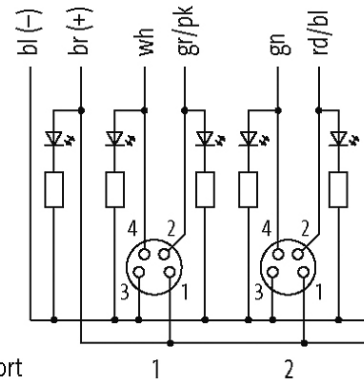

Product may differ from Image

Approvals



Contact Layout

PIN 1	(+)
PIN 2	(NC)/(S2)
PIN 3	(-)
PIN 4	(NO)/(S1)
LED display	LED (green): Power / LED (yellow): (S1) / LED (white): Signal (S2)

Cables

Cable number	412
No./diameter of wires	20×0.34 + 2×0.75 mm ²
Wire isolation	PVC
C-track properties	1.5 Mio.
Jacket Color	gray
Material (jacket)	PUR/PVC
Outer Ø	10.4 mm ±5%
Bend radius (fixed)	10 × outer Ø
Bend radius (moving)	12 × outer Ø
Temperature range (fixed)	-30...+70 °C
Temperature range (mobile)	-5...+60 °C

Technical Data

Operating voltage	24 V DC
Operating current per contact	max. 2 A

Total current	max. 8 A
Signal per port	2
Protection	IP65/IP67
Housing	Plastic, flame retardant
Locking of ports	Screw thread M8 × 1 mm

General data

Temperature range	-20...+80 °C, depending on cable quality
-------------------	--

Commercial data

country of origin	DE
customs tariff number	85444290
EAN	4048879056663
eClass	27279219
Packaging unit	1