

EXACT12, 4XM12, 4 POLE MOULDED CABLE

5.0m PUR/PVC 4X0.34+3X0.75

4-way, 4-pole
without LED, up to 125 V AC/DC
PUR/PVC
5.0 m

Further cable lengths on request. Plastic housings with good resistance against chemicals and oils. The resistance to aggressive media should be individually tested for your application. Further details on request.

[Link to Product](#)

Illustration



M12-Females 4-pole

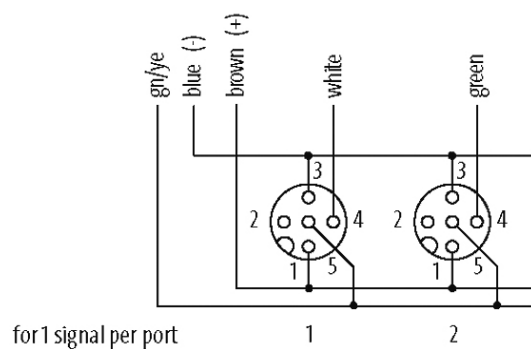
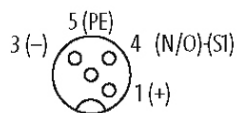

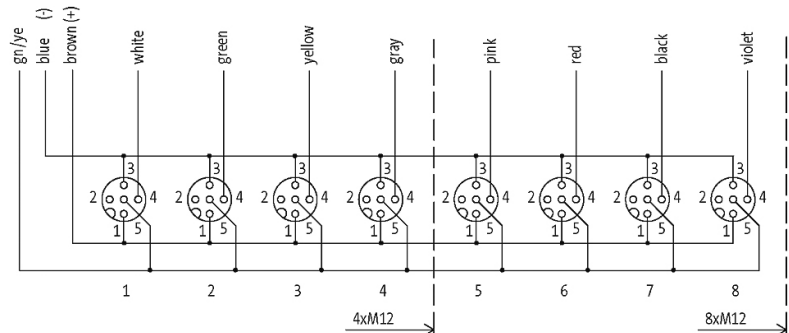
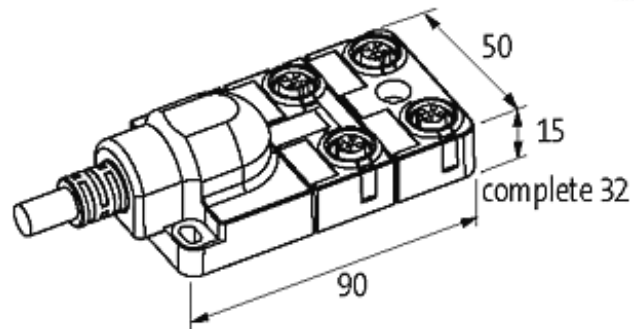

Product may differ from Image

Approvals



Contact Layout

PIN 1	(+)
PIN 3	(-)
PIN 4	(NO)/(S1)
PIN 5	(Earth)

Cables

Cable number	333
No./diameter of wires	4×0.34 + 3×0.75 mm ²
Wire isolation	PVC
C-track properties	2 Mio.
Jacket Color	gray
Material (jacket)	PUR/PVC
Outer Ø	7.4 mm ±5%
Bend radius (moving)	12 × outer Ø
Temperature range (fixed)	-30...+80 °C
Temperature range (mobile)	-5...+80 °C
Cable identification	333
Cable Type	2 (PUR/PVC)

Approval (cable)	UL (AWM-Style 21441/10955), CE conform
Cable weight [g/m]	91,3
Material (wire)	Cu wire, bare
Resistor (core)	max. 57 Ω /km (0.34 mm ²), max. 26 Ω /km (0.75 mm ²); (20 °C)
Single wire \varnothing (core)	0.15 mm (0.34 mm ²); 0.2 mm (0.75 mm ²)
Construction (core)	19 \times 0.15 mm (0.34 mm ²); 24 \times 0.2 mm (0.75 mm ²); (wire class 5)
Diameter (core)	4 \times 0.34 + 3 \times 0.75 mm ²
AWG	similar to AWG 22 (0.34 mm ²); similar to AWG 18 (0.75 mm ²)
Material (wire isolation)	PVC
Material property (wire isolation)	CFC-, cadmium-, silicone- and lead-free
Shore hardness (wire isolation)	43 \pm 5 D
Wire- \varnothing incl. isolation	1.3 mm \pm 5% (0.34 mm ²); 1.8 mm \pm 5% (0.75 mm ²)
Shield	no
Material (jacket)	PUR/PVC
Shore hardness (jacket)	87 \pm 5 A
Outer- \varnothing (jacket)	7.4 mm \pm 5%
Color (jacket)	gray
chemical resistance	good resistance to oil, gasoline and chemicals (EN 60811-404)
Nominal voltage	U0/U 300/300 V AC
Test voltage	2 000 V AC
Current load capacity	to DIN VDE 0298-4
Temperature range (fixed)	-30...+80 °C
Temperature range (mobile)	-5...+70 °C
Bend radius (fixed)	5 \times outer \varnothing
Bend radius (moving)	12 \times outer \varnothing
No. of bending cycles (C-track)	max. 2 Mio. (25 °C)
Traversing distance (C-track)	max. 5 m (horizontal)
Travel speed (C-track)	max. 2 m/s
Acceleration (C-track)	max. 10 m/s ²

Technical Data

Operating voltage	125 V AC/DC
Operating current per contact	max. 4 A
Total current	max. 8 A
Housing	Plastic, flame retardant
Protection	IP65/IP67
Locking of ports	Screw thread M12 \times 1 mm

General data

Temperature range	-20...+70 °C, depending on cable quality
-------------------	--

Commercial data

country of origin	DE
customs tariff number	85444290

EAN	4048879055987
eClass	27279219
Packaging unit	1