

EXACT12, 4XM12, 5-POLE, MOULDED CABLE

5.0m PUR 8x0,5+3x1,0, UL/CSA

4-way, 5-pole

5.0 m

Further cable lengths on request. Plastic housings with good resistance against chemicals and oils. The resistance to aggressive media should be individually tested for your application. Further details on request.

[Link to Product](#)

Illustration



M12-Females 5-pole

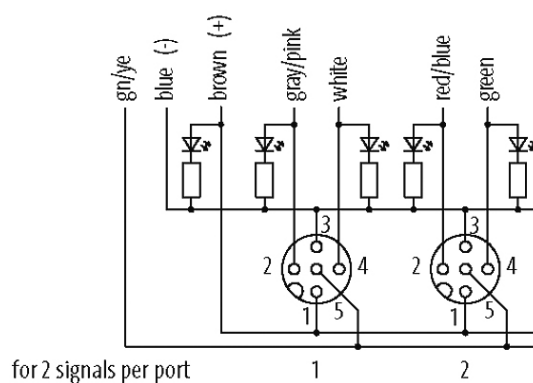
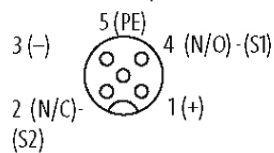

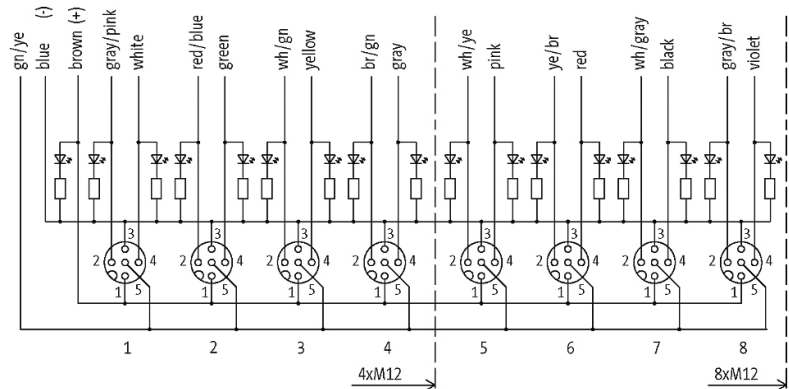
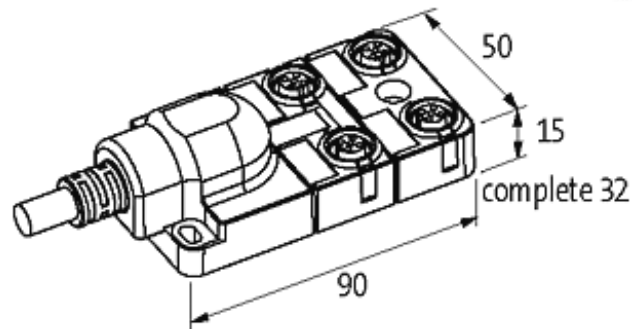

Product may differ from Image

Approvals



Contact Layout

PIN 1	(+)
PIN 2	(NC)/(S2)
PIN 3	(-)
PIN 4	(NO)/(S1)
PIN 5	(Earth)
LED display	LED (green): Power / LED (yellow): (S1) / LED (white): Signal (S2)

Cables

Cable number	448
No./diameter of wires	8×0.5 + 3×1.0 mm ²
Wire isolation	T PE (grpk, wh, rdbl, gn, whgn, ye, brgn, gr, br, bl, gnye)
C-track properties	5 Mio.
Jacket Color	gray
Material (jacket)	PUR (UL/CSA)
Outer Ø	9.1 mm ±5%
Bend radius (moving)	10 × outer Ø
Temperature range (fixed)	-40...+90 °C

Temperature range (mobile)	-40...+90 °C
Material (wire)	Cu wire, bare
Bend radius (fixed)	5 × outer Ø
Approval (cable)	UL (AWM-Style 20233), CSA

Technical Data

Operating voltage	24 V DC
Operating current per contact	max. 4 A
Total current	max. 8 A
Locking of ports	Screw thread M12 × 1 mm
Protection	IP65/IP67
Housing	Plastic, flame retardant

General data

Temperature range	-20...+70 °C, depending on cable quality
-------------------	--

Commercial data

country of origin	DE
customs tariff number	85444290
EAN	4048879055772
eClass	27279219
Packaging unit	1