

EXACT12, 4XM12, 5-POLE, MOULDED CABLE

5.0m PUR/PVC 8x0,34+3X0.75

4-way, 5-pole
for NPN signals 24 V DC
PUR/PVC
5.0 m

Further cable lengths on request. Plastic housings with good resistance against chemicals and oils. The resistance to aggressive media should be individually tested for your application. Further details on request.

[Link to Product](#)

Illustration



M12-Females 5-pole

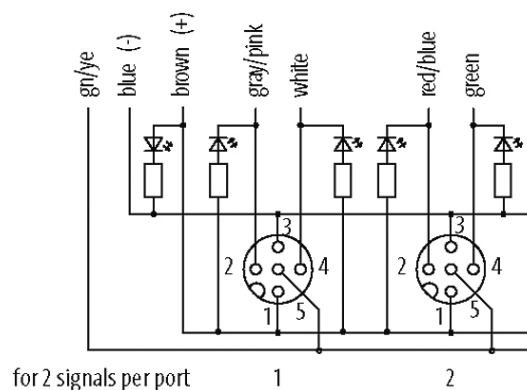
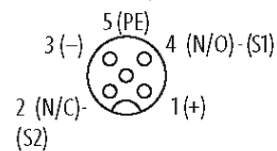

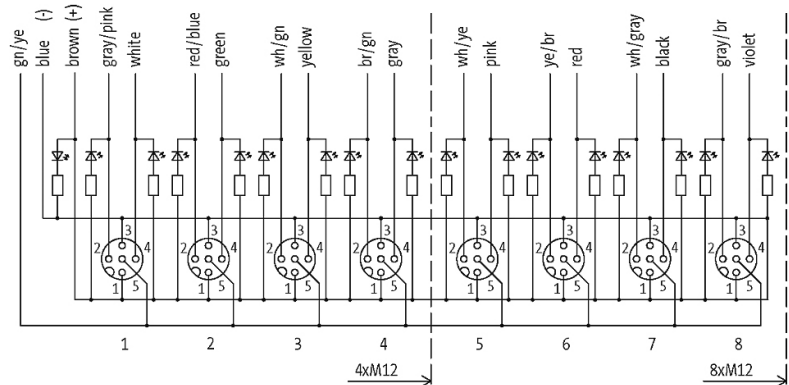
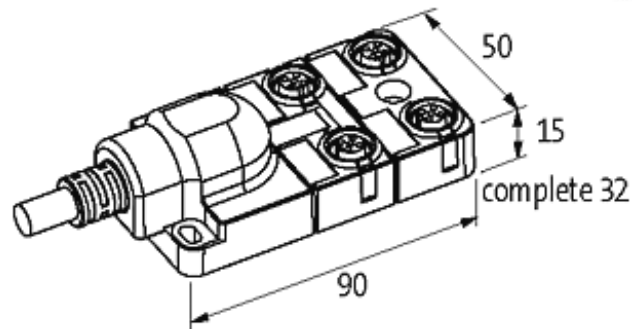

Product may differ from Image

Approvals



Contact Layout

PIN 1	(+)
PIN 2	(NC)/(S2)
PIN 3	(-)
PIN 4	(NO)/(S1)
PIN 5	(Earth)
LED display	LED (green): Power / LED (yellow): (S1) / LED (white): Signal (S2)

Cables

Cable number	363
No./diameter of wires	8×0.34 + 3×0.75 mm ²
Wire isolation	PVC
C-track properties	2 Mio.
Jacket Color	gray
Material (jacket)	PUR/PVC (UL/CSA)
Outer Ø	8.1 mm ±5%
Bend radius (moving)	10 × outer Ø
Temperature range (fixed)	-30...+80 °C

Temperature range (mobile)	-5...+70 °C
Cable identification	363
Cable Type	2 (PUR/PVC)
Approval (cable)	UL (AWM-Style 21441/10955), CE conform
Cable weight [g/m]	115,5
Material (wire)	Cu wire, bare
Resistor (core)	max. 57 Ω/km (0.34 mm ²), max. 26 Ω/km (0.75 mm ²); (20 °C)
Single wire Ø (core)	0.15 mm (0.34 mm ²); 0.2 mm (0.75 mm ²)
Construction (core)	19 × 0.15 mm (0.34 mm ²); 24 × 0.2 mm (0.75 mm ²); (wire class 5)
Diameter (core)	8×0.34 + 3×0.75 mm ²
AWG	similar to AWG 22 (0.34 mm ²); similar to AWG 18 (0.75 mm ²)
Material (wire isolation)	PVC
Material property (wire isolation)	CFC-, cadmium-, silicone- and lead-free
Shore hardness (wire isolation)	43 ±5 D
Wire-Ø incl. isolation	1.3 mm ±5% (0.34 mm ²); 1.8 mm ±5% (0.75 mm ²)
Shield	no
Material (jacket)	PUR/PVC
Shore hardness (jacket)	87 ±5 A
Outer-Ø (jacket)	8.1 mm ±5%
Color (jacket)	gray
chemical resistance	good resistance to oil, gasoline and chemicals (EN 60811-404)
Nominal voltage	U0/U 300/300 V AC
Test voltage	2 000 V AC
Current load capacity	to DIN VDE 0298-4
Temperature range (fixed)	-30...+80 °C
Temperature range (mobile)	-5...+70 °C
Bend radius (fixed)	5 × outer Ø
Bend radius (moving)	10 × outer Ø
No. of bending cycles (C-track)	max. 2 Mio. (25 °C)
Traversing distance (C-track)	max. 5 m (horizontal)
Travel speed (C-track)	max. 2 m/s
Acceleration (C-track)	max. 10 m/s ²

Technical Data

Operating voltage	24 V DC
Operating current per contact	max. 4 A
Total current	max. 8 A
Locking of ports	Screw thread M12 × 1 mm
Protection	IP65/IP67
Housing	Plastic, flame retardant

General data

Temperature range	-20...+70 °C, depending on cable quality
-------------------	--

Commercial data

country of origin	DE
customs tariff number	85444290
EAN	4048879055741
eClass	27279219
Packaging unit	1