

EXACT12, 4XM12, 1:1, FIXED CABLE

3.0m PUR/PVC 16x0,34+3X0.75

4-way UNIVERSAL
pre-wired homerun cable
without LED
3.0 m

Plastic housings with good resistance against chemicals and oils. The resistance to aggressive media should be individually tested for your application. Further details on request. Further cable lengths on request.

[Link to Product](#)**Illustration**

M12-Females 5-pole

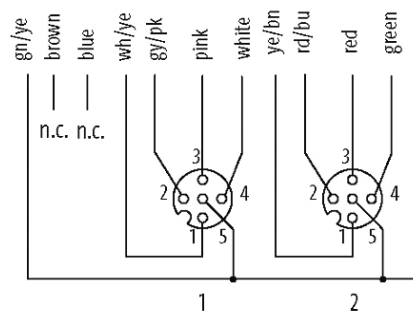
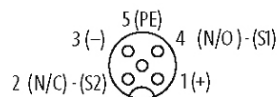

free arrangeable, contact 1:1 on terminals
for 4 signals per port, PIN5 bridged on terminals

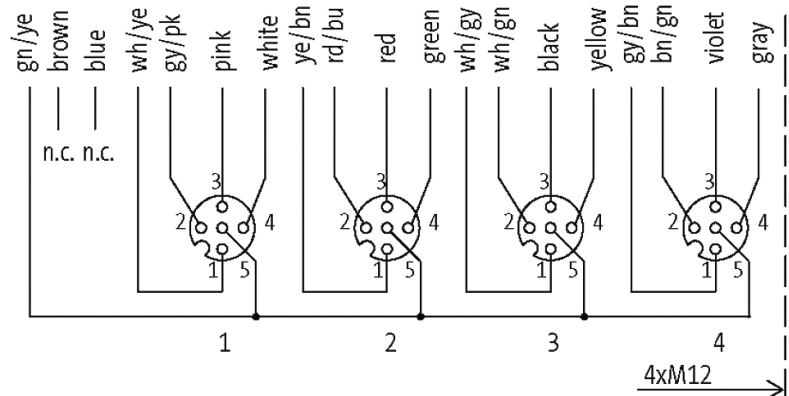
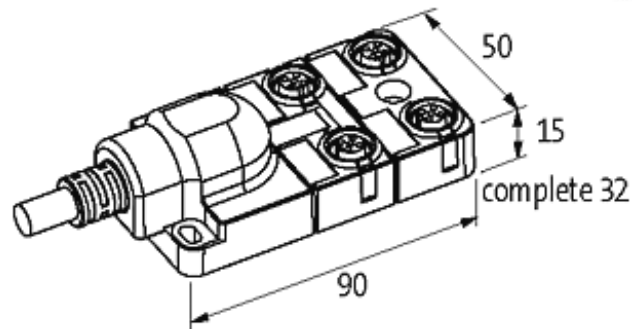

Product may differ from Image

Approvals

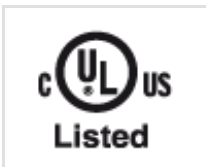

Contact Layout

PIN 1	(S1)
PIN 2	(S2)
PIN 3	(S3)
PIN 4	(S4)
PIN 5	(Earth)

Cables

Cable number	398
No./diameter of wires	16×0.34 + 3×0.75 mm ²
Wire isolation	PVC
C-track properties	2 Mio.
Jacket Color	gray
Material (jacket)	PUR/PVC (UL/CSA)
Outer Ø	10.0 mm ±5%
Bend radius (moving)	10 × outer Ø
Temperature range (fixed)	-30...+80 °C
Cable identification	398

The information in this brochure has been compiled with the utmost care.

Liability for the correctness completeness and topicality of the information is restricted to gross negligence. Version: 03/19

Murrelektronik GmbH | Falkenstraße 3 | 71570 Oppenweiler | Fon +49 (71 91) 47-0 | Fax +49 (71 91) 47-491000 | shop@murrelektronik.com | shop.murrelektronik.com

Cable Type	2 (PUR/PVC)
Approval (cable)	UL (AWM-Style 21441/10955), CE conform
Cable weight [g/m]	165,0
Material (wire)	Cu wire, bare
Resistor (core)	max. 57 Ω/km (0.34 mm ²), max. 26 Ω/km (0.75 mm ²); (20 °C)
Single wire Ø (core)	0.15 mm
Diameter (core)	16×0.34 + 3×0.75 mm ²
AWG	similar to AWG 22 (0.34 mm ²); similar to AWG 19 (0.75 mm ²)
Material (wire isolation)	PVC
Material property (wire isolation)	CFC-, cadmium-, silicone- and lead-free
Wire-Ø incl. isolation	1.3 mm ±5% (0.34 mm ²); 1.8 mm ±5% (0.75 mm ²)
Color/numbering of wires	wh, grpk, brgn, ye, whgn, gn, rdbl, vi, grbr, bk, whgr, rd, yebr, pk, whye, gr+bl, br, gnye longitudinally striped
Shield	no
Material (jacket)	PUR/PVC
Shore hardness (jacket)	85 ±5 A
Outer-Ø (jacket)	10.0 mm ±5%
Color (jacket)	gray
chemical resistance	good resistance to oil, gasoline and chemicals (EN 60811-404)
Nominal voltage	U0/U 300/300 V AC
Test voltage	2 000 V AC
Current load capacity	to DIN VDE 0298-4
Temperature range (fixed)	-30...+80 °C
Bend radius (moving)	10 × outer Ø
No. of bending cycles (C-track)	max. 2 Mio. (25 °C)

Technical Data

Operating voltage	42 V AC/DC
Operating current per contact	max. 4 A
Total current	max. 10 A
Locking of ports	Screw thread M12 × 1 mm
Protection	IP65/IP67
Housing	Plastic, flame retardant

General data

Temperature range	-20...+70 °C, depending on cable quality
-------------------	--

Commercial data

country of origin	DE
customs tariff number	85444290
EAN	4048879055369
eClass	27279219
Packaging unit	1