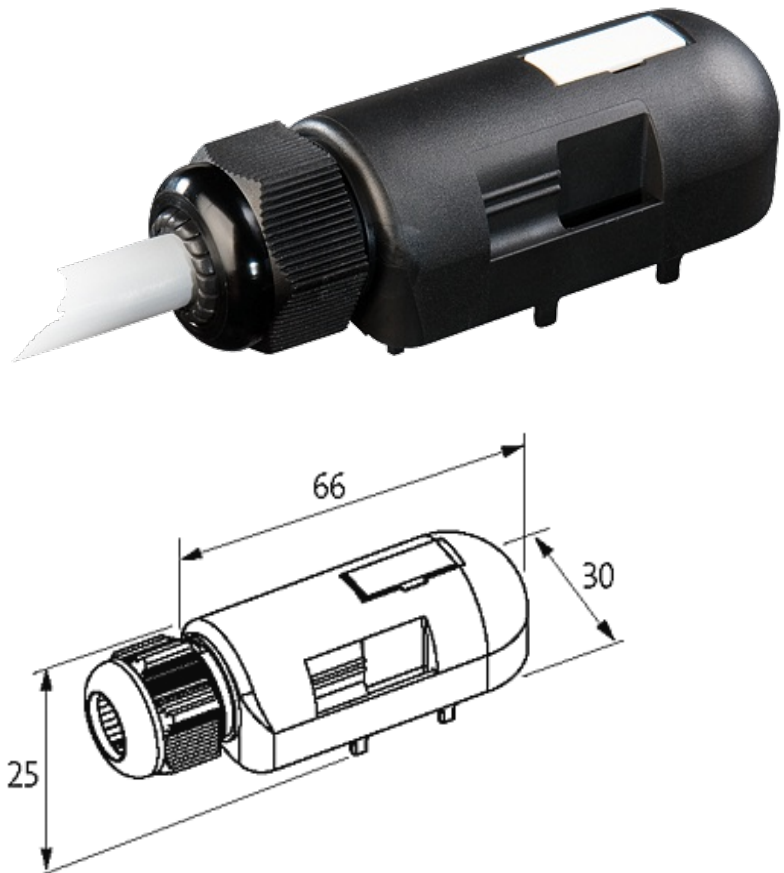

PRE-WIRED CAP FOR EXACT8, 6XM8, 3 POLE

5.0m PUR/PVC 6x0,34+2x0,75

for 6-way distribution box, 3-pole
PUR/PVC
5.0 m

Further cable lengths on request. Plastic housings with good resistance against chemicals and oils. The resistance to aggressive media should be individually tested for your application. Further details on request.

[Link to Product](#)**Illustration**

M8-Females 3-pole

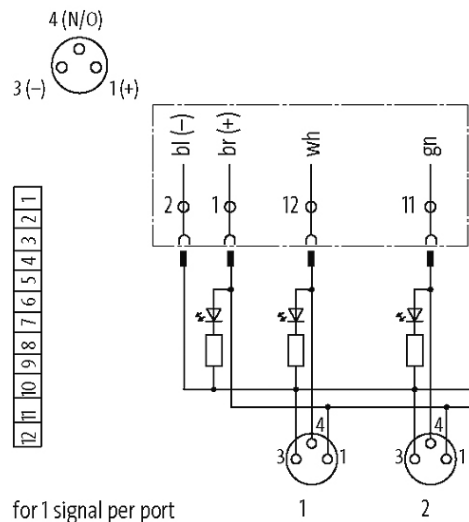

Product may differ from Image

Approvals



Cables

Cable number	350
No./diameter of wires	6×0.34 + 2×0.75 mm ²
Wire isolation	PVC (bl, wh, gn, ye, gr, pk, rd, br)
C-track properties	2 Mio.
Jacket Color	gray
Material (jacket)	PUR/PVC
Outer Ø	7.8 mm ±5%
Bend radius (moving)	10 × outer Ø
Temperature range (fixed)	-30...+80 °C
Temperature range (mobile)	-5...+60 °C
Shield	no
Cable identification	350
Cable Type	2 (PUR/PVC)
Cable weight [g/m]	94,60
Material (wire)	Cu wire, bare
Diameter (core)	6×0.34 + 2×0.75 mm ²
Material (wire isolation)	PVC
Material property (wire isolation)	CFC-, cadmium-, silicone- and lead-free
Shore hardness (wire isolation)	55 ±5 D
Material (jacket)	PUR/PVC
	CFC-, halogen-, cadmium-, silicone- and lead-free, matt, low-

Material property (jacket)	adhesion, machine easy to process, abrasion-resistant, hydrolysis and microbial resistant
Shore hardness (jacket)	85 ±5 A
Outer-Ø (jacket)	7.8 mm ±5%
Color (jacket)	gray
chemical resistance	good resistance to oil, gasoline and chemicals
thermal resistance	flame retardant
Nominal voltage	300/300 V AC
Test voltage	2 000 V AC
Temperature range (fixed)	-30...+80 °C
Temperature range (mobile)	-5...+70 °C
Bend radius (fixed)	5 × outer Ø
Bend radius (moving)	10 × outer Ø
No. of bending cycles (C-track)	max. 2 Mio. (25 °C)
Traversing distance (C-track)	max. 5 m (horizontal)
Travel speed (C-track)	max. 2 m/s
Acceleration (C-track)	max. 10 m/s ²

Technical Data

Housing	Plastic, flame retardant
Total current	max. 8 A

General data

Temperature range	-20...+80 °C, depending on cable quality
-------------------	--

Commercial data

country of origin	CZ
customs tariff number	85444290
EAN	4048879055093
eClass	27279219
Packaging unit	1