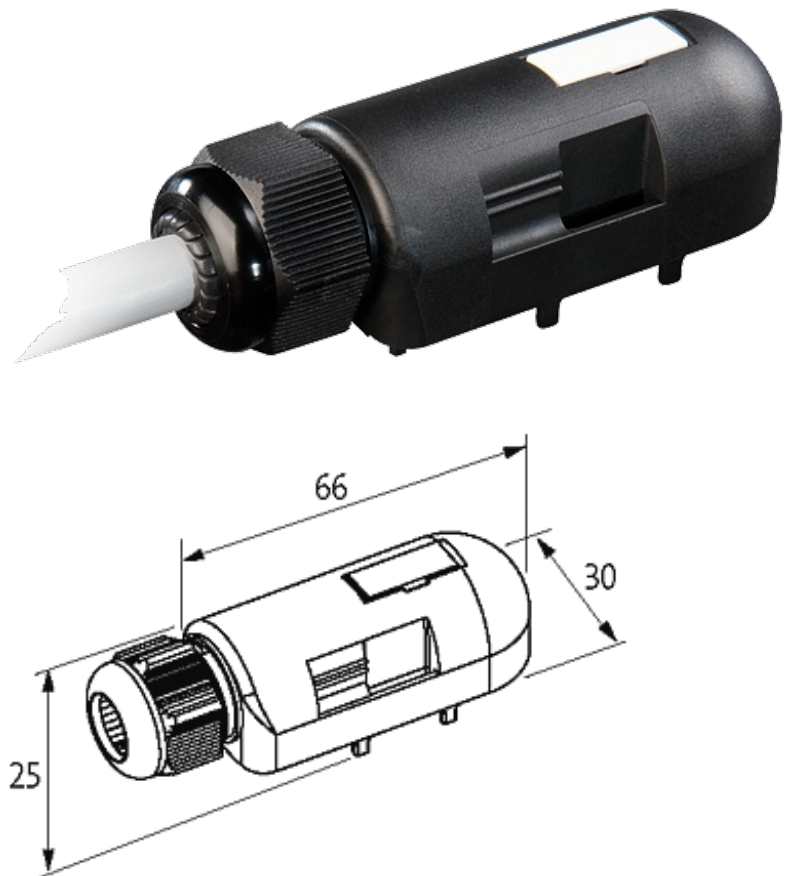

**PRE-WIRED CAP FOR EXACT8, 6XM8, 3 POLE**

15.0m PUR 6x0,34+2x0,75, UL/CSA

for 6-way distribution box, 3-pole  
15.0 m

Further cable lengths on request. Plastic housings with good resistance against chemicals and oils. The resistance to aggressive media should be individually tested for your application. Further details on request.

[Link to Product](#)**Illustration**

M8-Females 3-pole

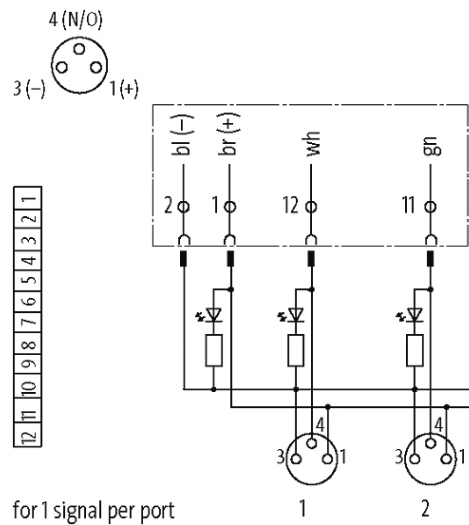

Product may differ from Image

### Approvals



### Cables

Cable number	356
No./diameter of wires	6×0.34 + 2×0.75 mm <sup>2</sup>
Wire isolation	TPE (ye, wh, gn, gr, pk, rd+br, bl)
C-track properties	5 Mio.
Jacket Color	gray
Material (jacket)	PUR (UL/CSA)
Outer Ø	8.5 mm ±5%
Bend radius (fixed)	5 × outer Ø
Bend radius (moving)	10 × outer Ø
Temperature range (fixed)	-40...+80 °C
Temperature range (mobile)	-5...+60 °C
Color (jacket)	gray

### Technical Data

Housing	Plastic, flame retardant
Total current	max. 8 A

### General data

Temperature range	-20...+80 °C, depending on cable quality
-------------------	--

### Commercial data

country of origin	CZ
customs tariff number	85444290

EAN	4048879055031
eClass	27279219
Packaging unit	1