

## PRE-WIRED CAP FOR EXACT8, 8XM8, 3 POLE

5.0m PUR/PVC 8x0,34+2x0,75

for 8-way distribution box, 3-pole  
PUR/PVC  
5.0 m

Further cable lengths on request. Plastic housings with good resistance against chemicals and oils. The resistance to aggressive media should be individually tested for your application. Further details on request.

### [Link to Product](#)

#### Illustration



M8-Females 3-pole

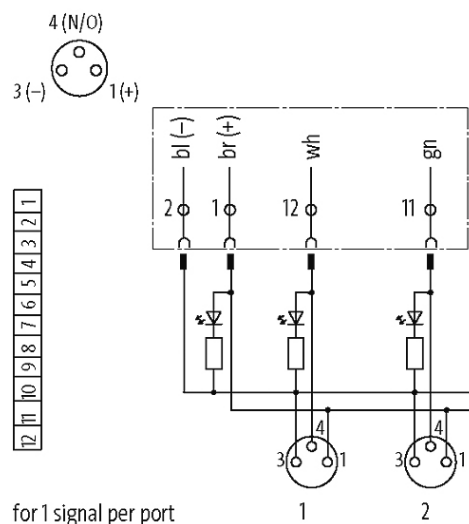

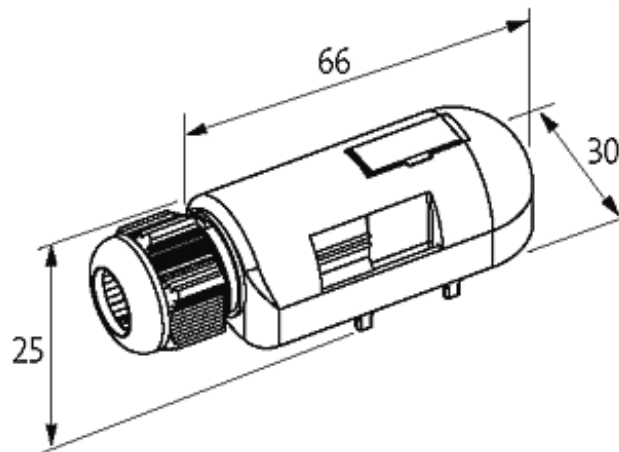

Product may differ from Image

### Approvals



### Cables

Cable number	357
No./diameter of wires	8×0.34 + 2×0.75 mm <sup>2</sup>
Wire isolation	PVC (vi, bk, rd, pk, gr, ye, gn, wh+br, bl)
C-track properties	2 Mio.
Jacket Color	gray
Material (jacket)	PUR/PVC
Outer Ø	8.6 mm ±5%
Bend radius (fixed)	5 × outer Ø
Bend radius (moving)	10 × outer Ø
Temperature range (fixed)	-30...+80 °C
Temperature range (mobile)	-5...+60 °C
Color (jacket)	gray

### Technical Data

Housing	Plastic, flame retardant
Total current	max. 8 A

### General data

Temperature range	-20...+80 °C, depending on cable quality
-------------------	--

### Commercial data

country of origin	CZ
customs tariff number	85444290
EAN	4048879054584
eClass	27143423
Packaging unit	1

