

EXACT8, 8XM8, 3 POLE

Conn.M12 12 pole

8-way, 3-pole

M12 (12-pole)

Inline face or side mounting

Plastic housings with good resistance against chemicals and oils. The resistance to aggressive media should be individually tested for your application. Further details on request.

[Link to Product](#)

Illustration

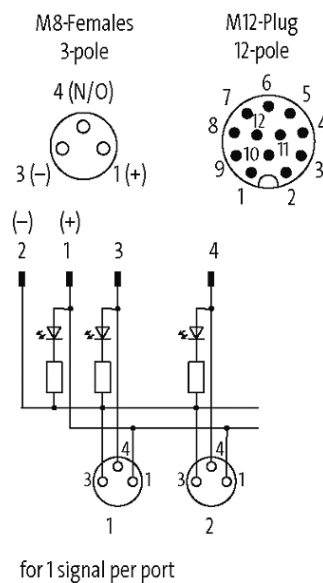

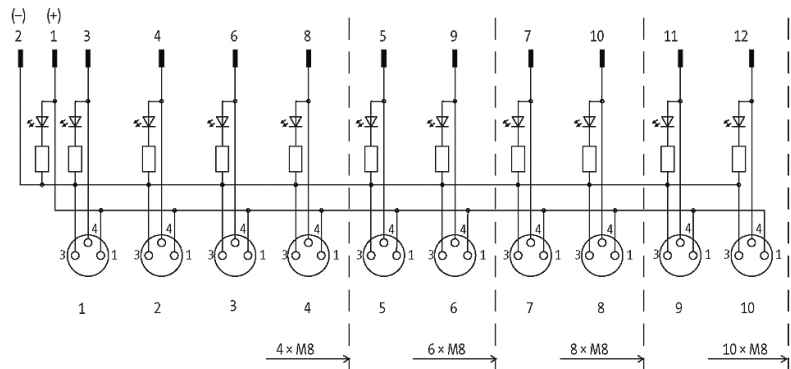
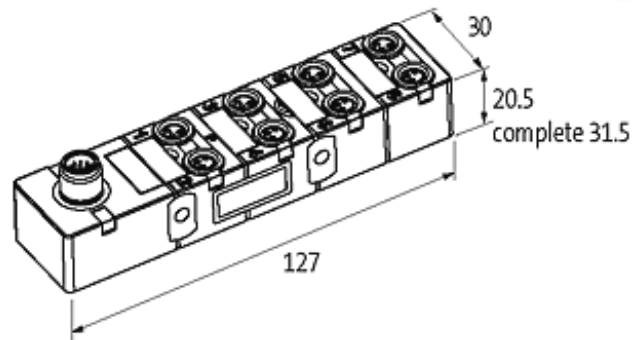

Product may differ from Image

Approvals



Contact Layout

PIN 1	(+)
PIN 3	(-)
PIN 4	(NO)/(S1)
LED display	LED (green): Power / LED (yellow): (S1)

Technical Data

Operating voltage	24 V DC
Operating current per contact	max. 1.5 A
Protection	IP67 inserted and tightened (EN 60529)
Housing	Plastic, flame retardant

General data

Temperature range	-20...+70 °C, depending on cable quality
-------------------	--

Commercial data

country of origin	DE
customs tariff number	85369010
EAN	4048879054515
eClass	27143423

Packaging unit

1