

## EXACT12, 8XM12, 4 POLE MOULDED CABLE

3.0m PUR/PVC 8x0,34+3X0.75, UL/CSA

8-way, 4-pole  
PUR/PVC  
3.0 m

Further cable lengths on request. Plastic housings with good resistance against chemicals and oils. The resistance to aggressive media should be individually tested for your application. Further details on request.

### [Link to Product](#)

#### Illustration



M12-Females 4-pole

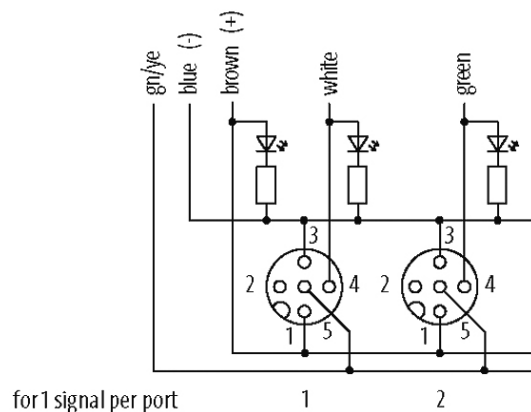
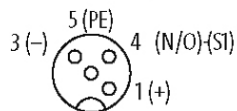

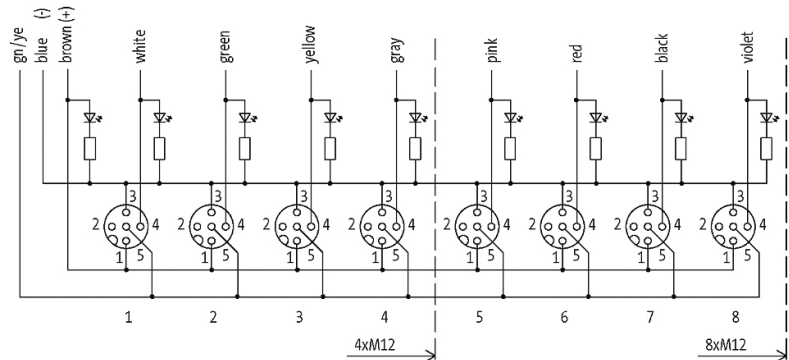
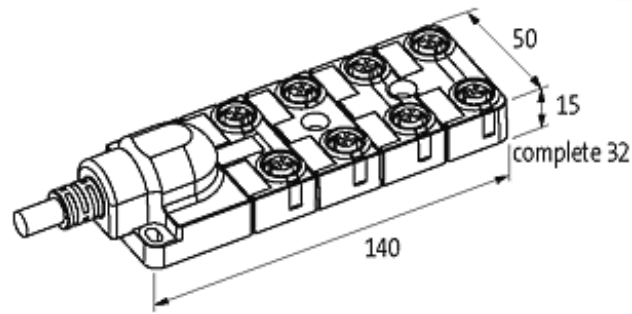

Product may differ from Image

## Approvals



## Contact Layout

PIN 1	(+)
PIN 3	(-)
PIN 4	(NO)/(S1)
PIN 5	(Earth)
LED display	LED (green): Power / LED (yellow): (S1)

## Cables

Cable number	362
No./diameter of wires	8×0.34 + 3×0.75 mm <sup>2</sup>
Wire isolation	PVC
C-track properties	2 Mio.
Jacket Color	gray
Material (jacket)	PUR/PVC (UL/CSA)
Outer Ø	8.1 mm ±5%
Bend radius (moving)	10 × outer Ø
Temperature range (fixed)	-30...+80 °C
Temperature range (mobile)	-5...+70 °C
Cable identification	362

Cable Type	2 (PUR/PVC)
Approval (cable)	UL (AWM-Style 20549/1731), CE conform
Cable weight [g/m]	115,5
Material (wire)	Cu wire, bare
Resistor (core)	max. 57 $\Omega$ /km (0.34 mm <sup>2</sup> ), max. 26 $\Omega$ /km (0.75 mm <sup>2</sup> ); (20 °C)
Single wire $\varnothing$ (core)	0.15 mm (0.34 mm <sup>2</sup> ); 0.2 mm (0.75 mm <sup>2</sup> )
Construction (core)	19 $\times$ 0.15 mm (0.34 mm <sup>2</sup> ); 24 $\times$ 0.2 mm (0.75 mm <sup>2</sup> ); (wire class 5)
Diameter (core)	8 $\times$ 0.34 + 3 $\times$ 0.75 mm <sup>2</sup>
AWG	similar to AWG 22 (0.34 mm <sup>2</sup> ); similar to AWG 18 (0.75 mm <sup>2</sup> )
Material (wire isolation)	PVC
Material property (wire isolation)	CFC-, cadmium-, silicone- and lead-free
Shore hardness (wire isolation)	43 $\pm$ 5 D
Wire- $\varnothing$ incl. isolation	1.3 mm $\pm$ 5% (0.34 mm <sup>2</sup> ); 1.8 mm $\pm$ 5% (0.75 mm <sup>2</sup> )
Color/numbering of wires	wh, vi, gn, ye, gr, pk, rd, bk+br, bl, gnye longitudinally striped
Shield	no
Material (jacket)	PUR/PVC
Outer- $\varnothing$ (jacket)	8.1 mm $\pm$ 5%
Color (jacket)	gray
chemical resistance	good resistance to oil, gasoline and chemicals (EN 60811-404)
Nominal voltage	U0/U 300/300 V AC
Test voltage	2 000 V AC
Current load capacity	to DIN VDE 0298-4
Temperature range (fixed)	-30...+80 °C
Temperature range (mobile)	-5...+70 °C
Bend radius (fixed)	5 $\times$ outer $\varnothing$
Bend radius (moving)	10 $\times$ outer $\varnothing$
No. of bending cycles (C-track)	max. 2 Mio. (25 °C)
Traversing distance (C-track)	max. 5 m (horizontal)
Travel speed (C-track)	max. 2 m/s
Acceleration (C-track)	max. 10 m/s <sup>2</sup>

### Technical Data

Operating voltage	24 V DC
Operating current per contact	max. 4 A
Total current	max. 8 A
Locking of ports	Screw thread M12 $\times$ 1 mm
Protection	IP65/IP67
Housing	Plastic, flame retardant

### General data

Temperature range	-20...+70 °C, depending on cable quality
-------------------	--

### Commercial data

country of origin	DE
-------------------	----

customs tariff number	85444290
EAN	4048879054270
eClass	27143423
Packaging unit	1