

EXACT12, 8XM12, 4 POLE MOULDED CABLE

3.0m PUR 8x0.5+3x1.0, UL/CSA

8-way, 4-pole

Further cable lengths on request. Plastic housings with good resistance against chemicals and oils. The resistance to aggressive media should be individually tested for your application. Further details on request.

[Link to Product](#)

Illustration



M12-Females 4-pole

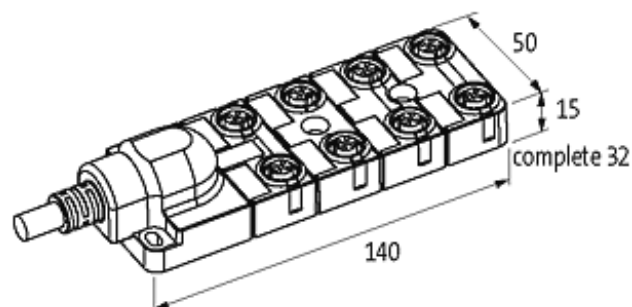
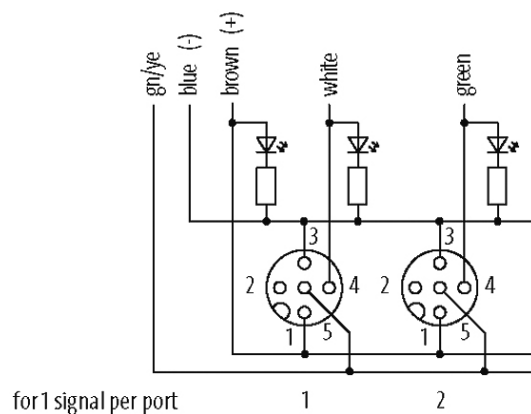
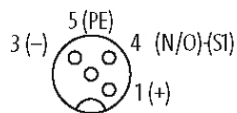

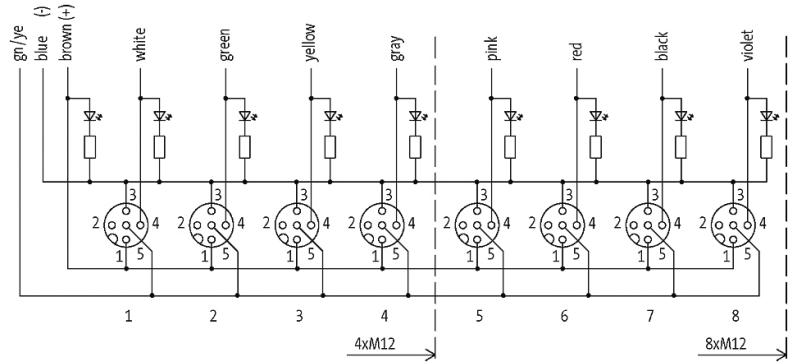

Product may differ from Image

Approvals

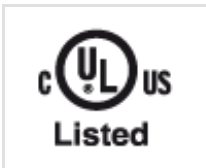

Contact Layout

PIN 1	(+)
PIN 3	(-)
PIN 4	(NO)/(S1)
PIN 5	(Earth)
LED display	LED (green): Power / LED (yellow): (S1)

Cables

Cable number	447
No./diameter of wires	8×0.5 + 3×1.0 mm ²
C-track properties	5 Mio.
Jacket Color	gray
Material (jacket)	PUR (UL/CSA)
Outer Ø	9.4 mm ±5%
Bend radius (fixed)	5 × outer Ø
Bend radius (moving)	10 × outer Ø
Temperature range (fixed)	-40...+80 °C
Temperature range (mobile)	-5...+80 °C

Technical Data

Operating voltage	24 V DC
Operating current per contact	max. 4 A
Total current	max. 8 A
Locking of ports	Screw thread M12 × 1 mm
Protection	IP65/IP67
Housing	Plastic, flame retardant

General data

Temperature range -20...+70 °C, depending on cable quality

Commercial data

country of origin	DE
customs tariff number	85444290
EAN	4048879308953
eClass	27143423
Packaging unit	1