

EXACT12, 8XM12, 4 POLE CAP, PLUG. SPRING TERM.

Self wireable, PNP LED

8-way, 4-pole

Form PNP

Spring clamp plug-in terminals

Plastic housings with good resistance against chemicals and oils. The resistance to aggressive media should be individually tested for your application. Further details on request.

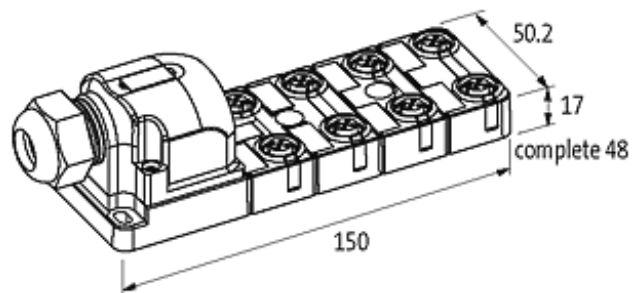
[Link to Product](#)**Illustration**

M12-Females 4-pole

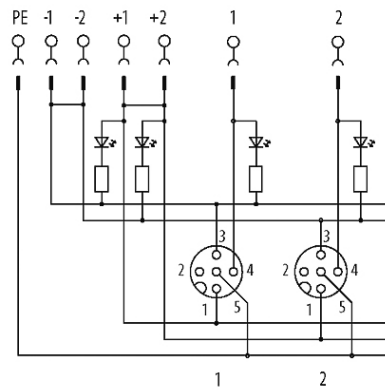
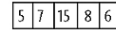
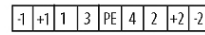
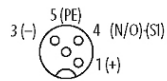

for 1 signal per port

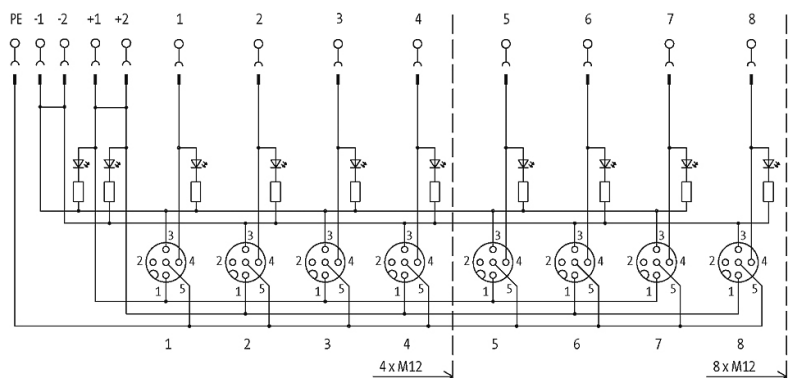
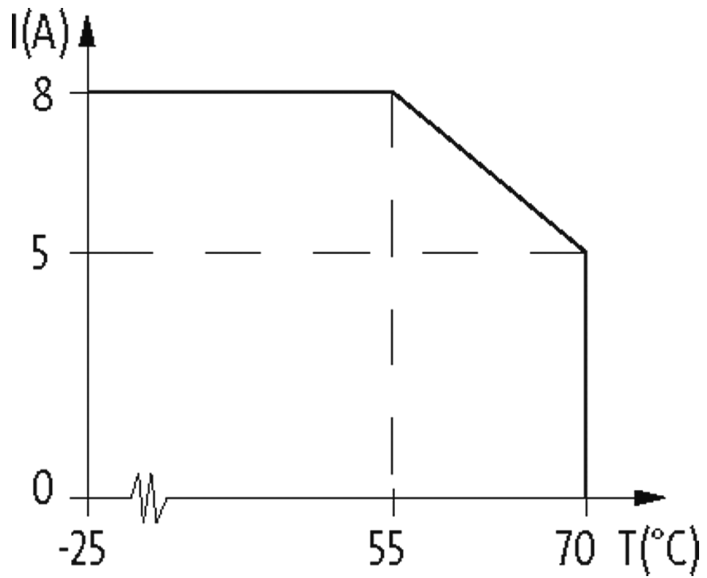

Product may differ from Image

Approvals



Contact Layout

PIN 1	(+)
PIN 3	(-)
PIN 4	(NO)/(S1)
PIN 5	(Earth)
LED display	LED (green): Power / LED (yellow): (S1)

Technical Data

Operating voltage	24 V DC
Operating current per contact	max. 4 A
Total current	max. 8 A
Connection	Spring clamp plug-in terminals: max. 1.5 mm ² (AWG 16)
Protection	IP65/IP67
Housing	Plastic, flame retardant

General data

Temperature range	-20...+70 °C
-------------------	--------------

Commercial data

country of origin	DE
customs tariff number	85369010
EAN	4048879054171
eClass	27143423
Packaging unit	1