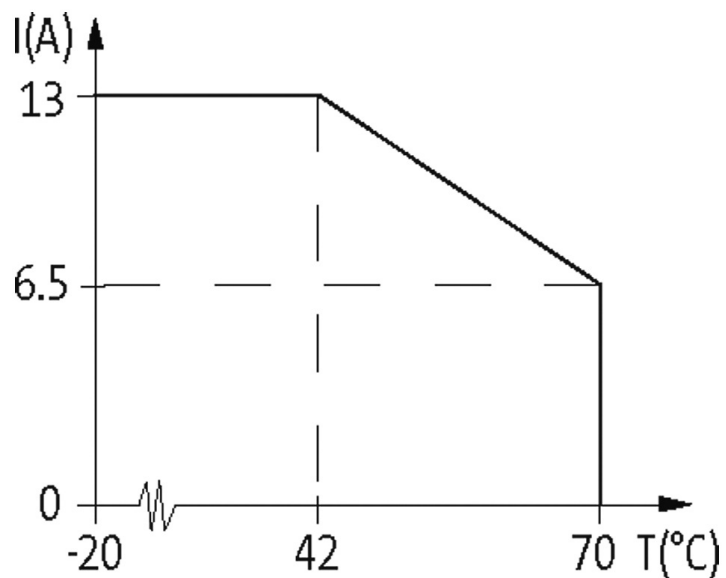

EXACT12, 8XM12, 5-POLE, MOULDED CABLE

10.0m PUR 16x0,5+3x1,0, UL/CSA

8-way, 5-pole
10.0 m

Further cable lengths on request. Plastic housings with good resistance against chemicals and oils. The resistance to aggressive media should be individually tested for your application. Further details on request.

[Link to Product](#)**Illustration**

M12-Females 5-pole

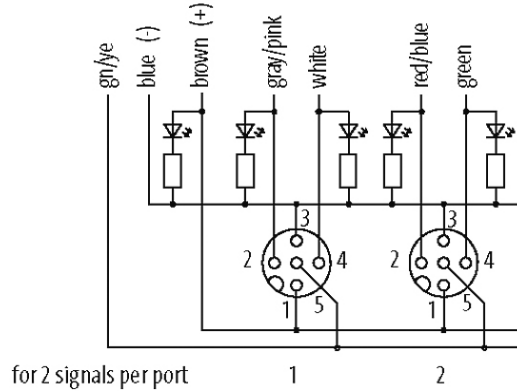
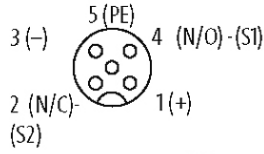

for 2 signals per port

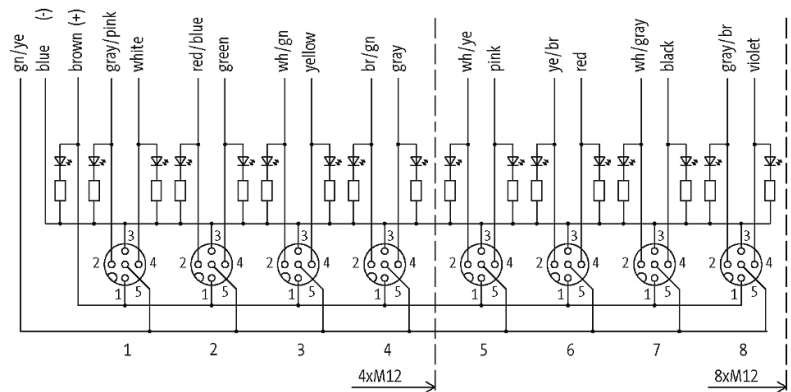
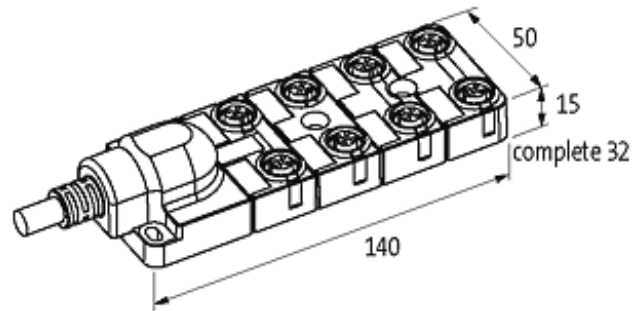

Product may differ from Image

Approvals



Contact Layout

PIN 1	(+)
PIN 2	(NC)/(S2)
PIN 3	(-)

PIN 4	(NO)/(S1)
PIN 5	(Earth)
LED display	LED (green): Power / LED (yellow): (S1) / LED (white): Signal (S2)

Cables

Cable number	452
No./diameter of wires	16×0.5 + 3×1.0 mm ²
Wire isolation	T PE (grpk, wh, rdbl, gn, whgn, ye, brgn, gr, whye, pk, yebr, rd, whgr, bk, grbr, vi, br, bl, gnye)
C-track properties	5 Mio.
Jacket Color	gray
Material (jacket)	PUR (UL/CSA)
Outer Ø	11.5 mm ±5%
Bend radius (moving)	10 × outer Ø
Temperature range (fixed)	-40...+80 °C
Temperature range (mobile)	-5...+80 °C
Cable identification	452
Cable weight [g/m]	231,0
Material (wire)	Cu wire, bare
Resistor (core)	max. 39 Ω/km (0.5 mm ²); max. 20 Ω/km (1.0 mm ²); (20 °C)
Single wire Ø (core)	0.1 mm
Diameter (core)	16×0.5 + 3×1.0 mm ²
AWG	similar to AWG 20 (0.5 mm ²); similar to AWG 17 (1.0 mm ²)
Material (wire isolation)	T PE-E
Shore hardness (wire isolation)	55 ±3 D
Wire-Ø incl. isolation	1.6 mm ±5% (0.5 mm ²); 2.1 mm ±5% (1.0 mm ²)
Material (jacket)	PUR
Outer-Ø (jacket)	11.6 mm ±5%
Color (jacket)	gray
chemical resistance	good resistance to oil, gasoline and chemicals
Nominal voltage	300/300 V AC
Test voltage	2 000 V AC
Temperature range (fixed)	-40...+80 °C
Temperature range (mobile)	-5...+80 °C
Bend radius (moving)	10 × outer Ø
No. of bending cycles (C-track)	max. 5 Mio.
Travel speed (C-track)	max. 2 m/s
Torsion stress	±180° /m
Approval (cable)	UL (AWM-Style 20233), CSA

Technical Data

Operating voltage	24 V DC
Operating current per contact	max. 4 A
Total current	max. 8 A

Locking of ports	Screw thread M12 × 1 mm
------------------	-------------------------

Protection	IP65/IP67
------------	-----------

Housing	Plastic, flame retardant
---------	--------------------------

General data

Temperature range	-20...+70 °C, depending on cable quality
-------------------	--

Commercial data

country of origin	DE
-------------------	----

customs tariff number	85444290
-----------------------	----------

EAN	4048879053976
-----	---------------

eClass	27143423
--------	----------

Packaging unit	1
----------------	---