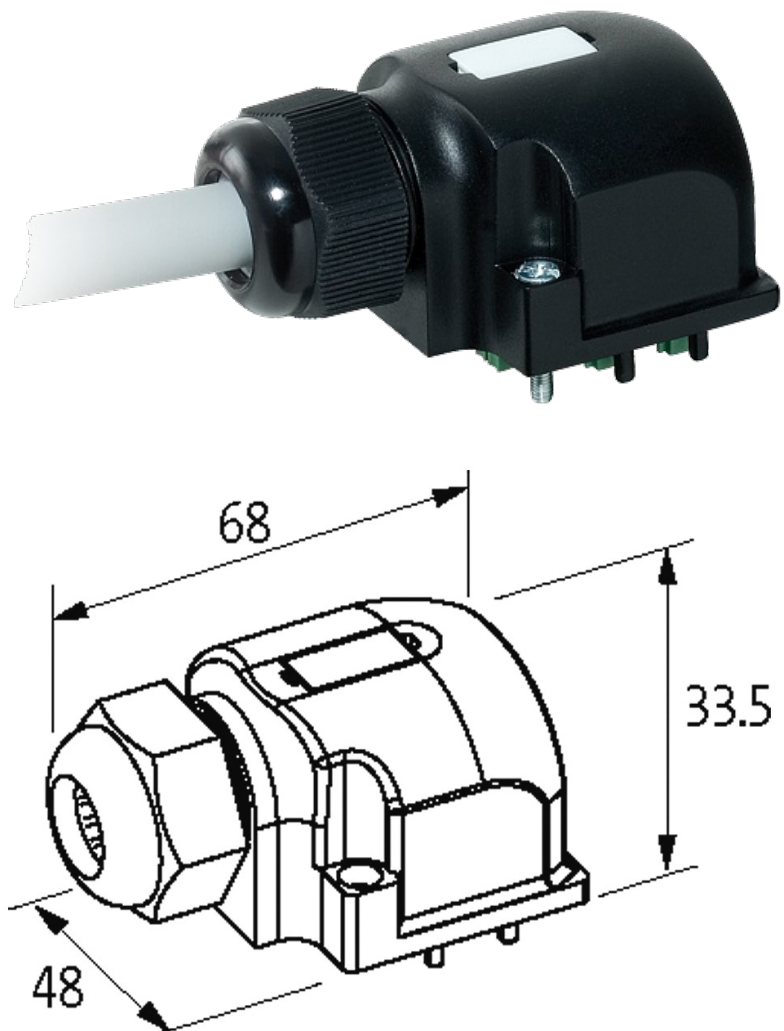

**CAP FOR D-BOX M12 8-WAY 5-POLE**

Pot.-sep. 10m PUR/PVC, 16x0,34+5X0.75

for 8-way distribution boxes, 5-pole  
potentially separated

Further cable lengths on request. Plastic housings with good resistance against chemicals and oils. The resistance to aggressive media should be individually tested for your application. Further details on request.

**[Link to Product](#)****Illustration**

M12-Females 5-pole

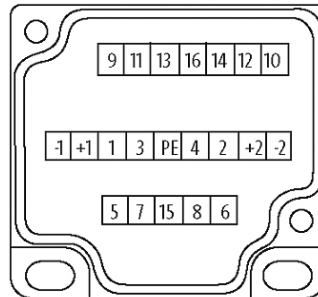
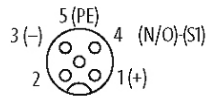

for 2 signals per port

Product may differ from Image

### Cables

Cable number	404
No./diameter of wires	16×0.34 + 5×0.75 mm <sup>2</sup>
Wire isolation	PVC
C-track properties	1.5 Mio.
Jacket Color	gray
Material (jacket)	PUR/PVC
Material (wire)	Cu wire, bare
Resistor (core)	max. 57 Ω/km (0.34 mm <sup>2</sup> ), max. 26 Ω/km (0.75 mm <sup>2</sup> ); (20 °C)
Outer Ø	12.5 mm ±5%
Bend radius (fixed)	10 × outer Ø
Bend radius (moving)	12 × outer Ø
Temperature range (fixed)	-30...+80 °C
Temperature range (mobile)	-30...+80 °C

### Technical Data

Housing	Plastic, flame retardant
Total current	max. 8 A

### General data

Temperature range	-20...+80 °C, depending on cable quality
-------------------	--

### Commercial data

country of origin	CZ
customs tariff number	85444290
EAN	4048879053624
eClass	27143423
Packaging unit	1