

EXACT12 SAFETY, FIX. CABLE, P1-4 M12 5POLE LED,

P5-8 M12 4/3-pol 1:1 no LED, 5m PUR/PVC

8-way, 5-pole

Homerun cable with spring clamp terminals

4-/3-pole

PUR/PVC

5.0 m

Further cable lengths on request. Plastic housings with good resistance against chemicals and oils. The resistance to aggressive media should be individually tested for your application. Further details on request.

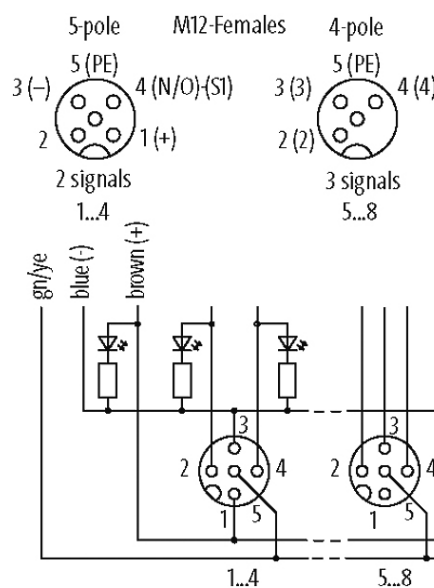
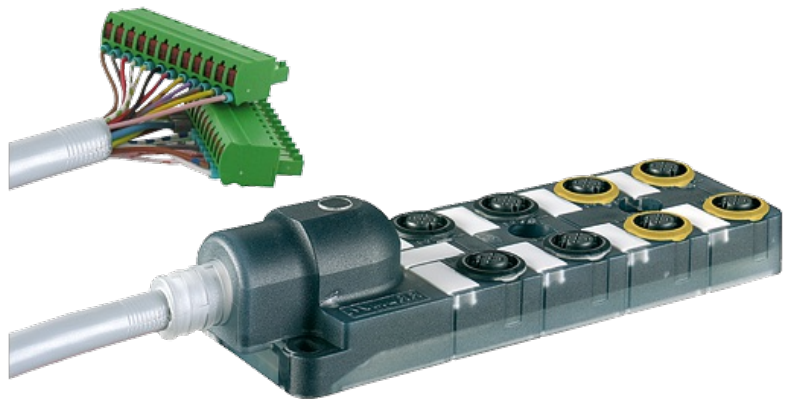
[Link to Product](#)**Illustration**

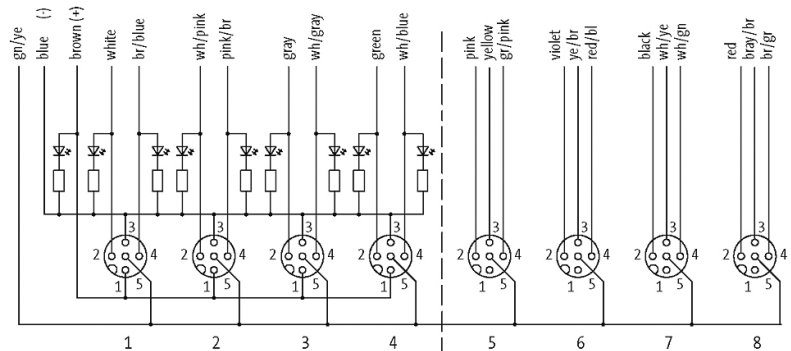
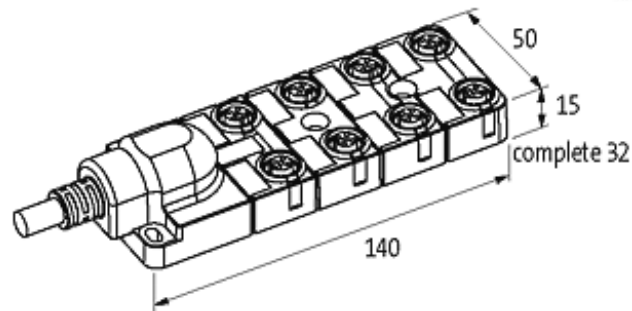

Product may differ from Image

Approvals



Contact Layout

PIN 1	(+) port 1...4
PIN 2	(NC)/(S2) port 1...4; (S1) port 5...8
PIN 3	(-) port 1...4; (S2) port 5...8
PIN 4	(NO)/(S1) port 1...4; (S3) port 5...8
PIN 5	(Earth)
LED display	LED (green): Power / LED (yellow): (S1) / LED (white): Signal (S2) port 1...4

Cables

Cable number	407
No./diameter of wires	20×0.34 + 3×0.75 mm ²
Wire isolation	PVC
C-track properties	2 Mio.
Jacket Color	gray
Material (jacket)	PUR/PVC (UL/CSA)
Outer Ø	10.0 mm ±5%
Bend radius (fixed)	10 × outer Ø
Bend radius (moving)	12 × outer Ø
Temperature range (fixed)	-30...+80 °C

The information in this brochure has been compiled with the utmost care.

Liability for the correctness completeness and topicality of the information is restricted to gross negligence. Version: 03/19

Murrelektronik GmbH | Falkenstraße 3 | 71570 Oppenweiler | Fon +49 (71 91) 47-0 | Fax +49 (71 91) 47-491000 | shop@murrelektronik.com | shop.murrelektronik.com

Temperature range (mobile) -5...+60 °C

Technical Data

Operating voltage	24 V DC
Operating current per contact	max. 4 A
Total current	max. 8 A
Protection	IP65/IP67
Housing	Plastic, flame retardant
Locking of ports	Screw thread M12 × 1 mm

General data

Temperature range -20...+60 °C, depending on cable quality

Commercial data

country of origin	DE
customs tariff number	85444290
EAN	4048879053563
eClass	27143423
Packaging unit	1