

## MVP12 Steel F&B, 8XM12, 5POLE, PRE-WIRED CABLE

20.0m TPE-V 16x0.5+3x1.0, UL/CSA

5-pole  
15.0 m

Further cable lengths on request. The resistance to aggressive media should be individually tested for your application. Further details on request.

### [Link to Product](#)

#### Illustration

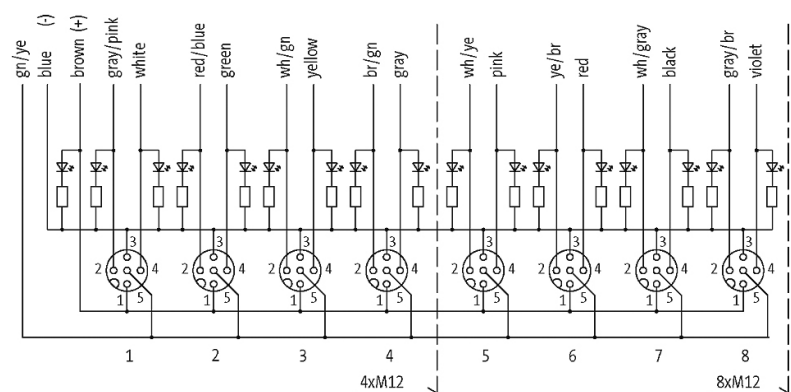
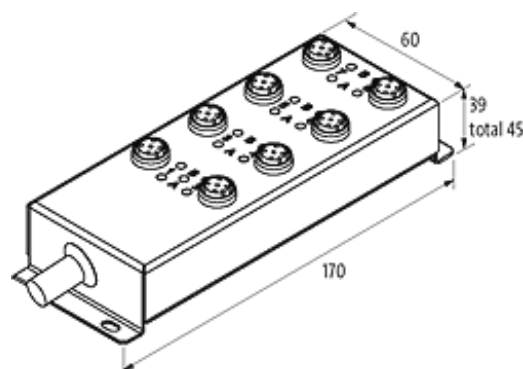

M12-Females 5-pole

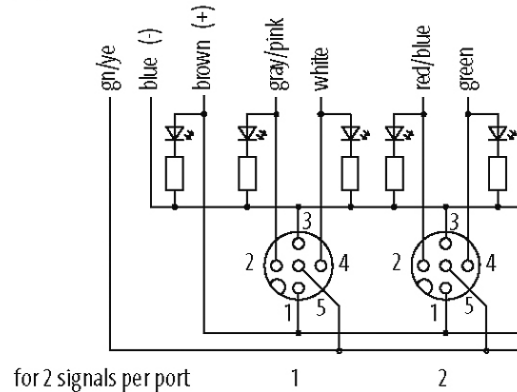
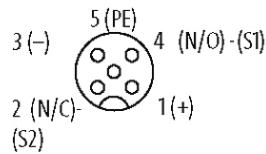

Product may differ from Image

### Contact Layout

PIN 1	(+)
PIN 2	(NC)/(S2)
PIN 3	(-)
PIN 4	(NO)/(S1)
PIN 5	(Earth)
LED display	LED (green): Power / LED (yellow): (S1/S2)

### Cables

Cable number	453
No./diameter of wires	16×0.5 + 3×1.0 mm <sup>2</sup>
Wire isolation	T PE (grpk, wh, rdbl, gn, whgn, ye, brgn, gr, whye, pk, yebr, rd, whgr, bk, grbr, vi, br, bl, gnye)
C-track properties	5 Mio.
Jacket Color	gray
Material (jacket)	T PE-V
Outer Ø	11.6 mm ±5%
Bend radius (moving)	10 × outer Ø
Temperature range (fixed)	-40...+90 °C
Temperature range (mobile)	-20...+90 °C
Cable identification	453
Approval (cable)	FDA regulation 21 CFR 177.2600, CE conform
Cable weight [g/m]	199,10
Material (wire)	Cu wire, bare
Resistor (core)	max. 39 Ω/km (0.5 mm <sup>2</sup> ); max. 20 Ω/km (1.0 mm <sup>2</sup> ); (20 °C)
Single wire Ø (core)	0.1 mm
Diameter (core)	16×0.5 + 3×1.0 mm <sup>2</sup>
AWG	similar to AWG 20 (0.5 mm <sup>2</sup> ); similar to AWG 17 (1.0 mm <sup>2</sup> )

Material (wire isolation)	PP
Material property (wire isolation)	CFC-, halogen-, cadmium-, silicone- and lead-free
Shore hardness (wire isolation)	65 ±3 D
Wire-Ø incl. isolation	1.6 mm ±5% (0.5 mm <sup>2</sup> ); 2.1 mm ±5% (1.0 mm <sup>2</sup> )
Shield	no
Material (jacket)	TPE-V
Material property (jacket)	CFC-, halogen-, cadmium-, silicone- and lead-free
Shore hardness (jacket)	80 ±5 A
Outer-Ø (jacket)	11.6 mm ±5%
Color (jacket)	gray
Nominal voltage	300 V AC
Test voltage	2 000 V AC
Current load capacity	to DIN VDE 0298-4
Temperature range (fixed)	-40...+90 °C
Temperature range (mobile)	-20...+90 °C
Bend radius (fixed)	5 × outer Ø
Bend radius (moving)	10 × outer Ø
No. of bending cycles (C-track)	max. 5 Mio. (25 °C)
Traversing distance (C-track)	max. 5 m (horizontal)
Travel speed (C-track)	max. 3.3 m/s
Acceleration (C-track)	max. 5 m/s <sup>2</sup>

#### Technical Data

Operating voltage	24 V DC
Operating current per contact	max. 4 A
Total current	max. 12 A
Locking of ports	Screw thread M12 × 1 mm
Protection	IP65, IP68, IP69K inserted and tightened (EN 60529)
Housing	Stainless Steel 1.4404 (V4A)

#### General data

Temperature range	-30...+80 °C
-------------------	--------------

#### Commercial data

country of origin	DE
customs tariff number	85444290
EAN	4048879554176
eClass	27143423
Packaging unit	1