

MET 1-PHASE CONTROL AND ISOLATION TRANSFORMER

P: 2000VA IN: 230VAC+/- 5% OUT: 230VAC

Single-phase - Control and Isolation Transformers
2 000 VA
Isolation class T 40/B

[Link to Product](#)

Illustration

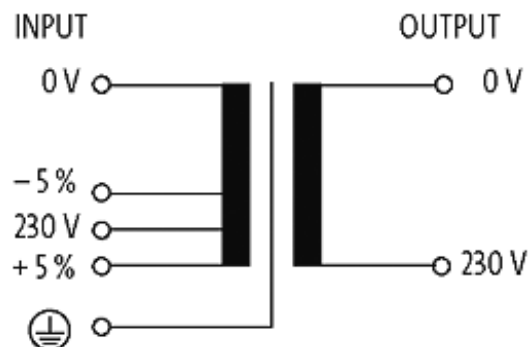
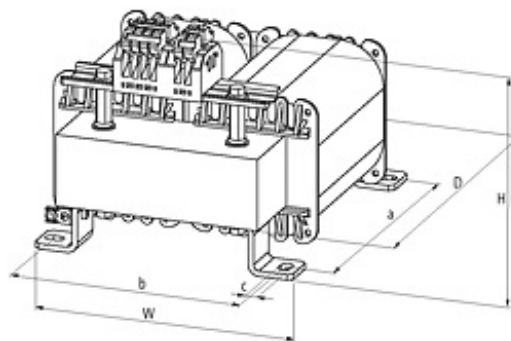

Product may differ from image

The information in this brochure has been compiled with the utmost care.

Liability for the correctness completeness and topicality of the information is restricted to gross negligence. Version: 03/19

Murrelektronik GmbH | Falkenstraße 3 | 71570 Oppenweiler | Fon +49 (71 91) 47-0 | Fax +49 (71 91) 47-491000 | shop@murrelektronik.com | shop.murrelektronik.com

Product may differ from image

Approvals



Input

Input voltage	230 V AC \pm 5%
Frequency	50...60 Hz
Short-circuit current	334.8 A (230 V AC)
Input current	9.2 A (230 V AC)
Inrush current	142.2 A (230 V AC)

General data

Standards	EN 61558-1, EN 61558-2-4, EN 62041 category 0
Test isolation voltage	4 kV (prim./sec.)
Dimensions H x W x D	170x195x250 mm
Fixing centers a x b x c	200x174x9 mm
Drill hole \varnothing	9x14 mm
Mounting method	Long-hole mounting
Temperature range	-20...+40 °C (storage temperature -40...+80 °C)

Output

Output voltage	230 V AC
Output rating	2 000 VA

Commercial data

country of origin	CZ
customs tariff number	85043200
EAN	4048879078832
eClass	27031302
Packaging unit	1