

MET 1-PHASE CONTROL AND ISOLATION TRANSFORMER

P: 2000VA IN: 400VAC+/- 5% OUT: 230VAC

Single-phase - Control and Isolation Transformers
2 000 VA
Isolation class T 40/B

[Link to Product](#)

Illustration

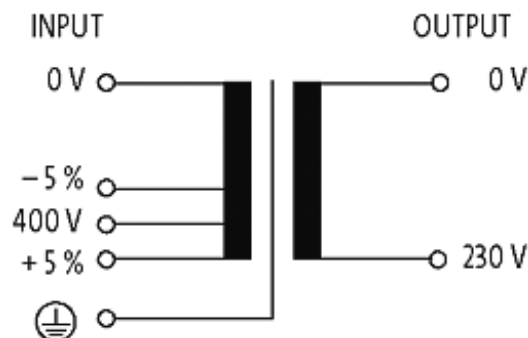
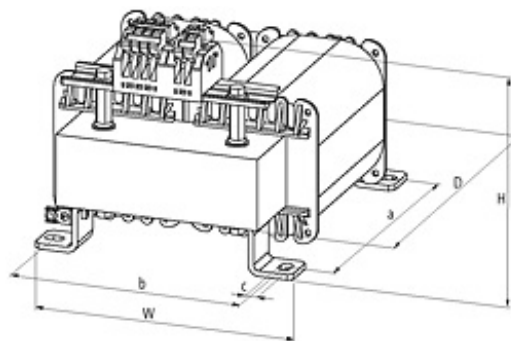

Product may differ from image

Product may differ from image

Approvals



Input

Input voltage	400 V AC \pm 5%
Frequency	50...60 Hz
Short-circuit current	182 A (400 V AC)
Input current	5.1 A (400 V AC)
Inrush current	76 A (400 V AC)

General data

Standards	EN 61558-1, EN 61558-2-4, EN 62041 category 0
Test isolation voltage	4 kV (prim./sec.)
Dimensions H x W x D	170x195x250 mm
Fixing centers a x b x c	200x174x9 mm
Drill hole \varnothing	9x14 mm
Mounting method	Long-hole mounting
Temperature range	-20...+40 °C (storage temperature -40...+80 °C)

Output

Output voltage	230 V AC
Output rating	2 000 VA

Commercial data

country of origin	CZ
customs tariff number	85043200
EAN	4048879078825
eClass	27031302
Packaging unit	1