

## MST 1-PHASE CONTROL AND ISOLATION TRANSFORMER

P: 2000VA IN: 208...550VAC OUT: 2x115VAC

Single-phase - Control and Isolation Transformers  
2 000 VA  
Isolation class T 40/B

Other voltages on request.

### [Link to Product](#)

#### Illustration

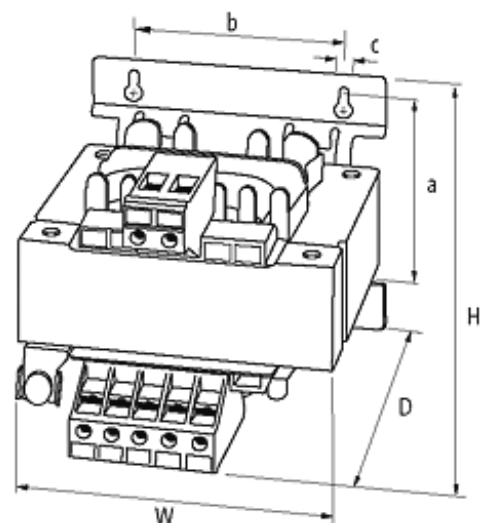



Packaging unit

1