

MST 1-PHASE CONTROL AND ISOLATION TRANSFORMER

P: 5000VA IN: 208...550VAC OUT: 2x115VAC

Single-phase - Control and Isolation Transformers
5 000 VA
Isolation class T 40/B

Other voltages on request.

[Link to Product](#)

Illustration

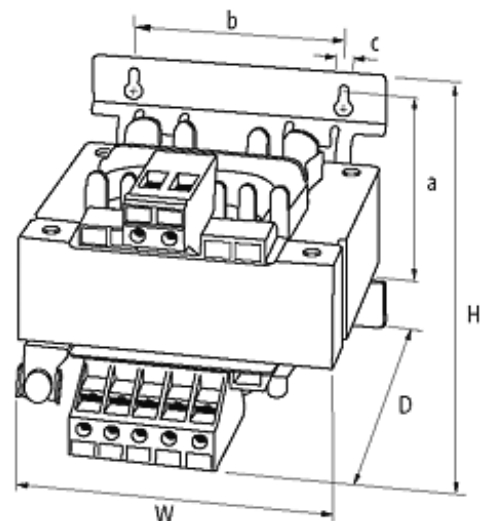

Packaging unit

1