

MTS 1-PHASE SAFETY TRANSFORMER

P: 160VA IN: 230/400VAC +/- 15VAC OUT: 24VAC

Single-phase safety transformer
160 VA
Isolation class T 40/B

Other voltages on request.

[Link to Product](#)

Illustration

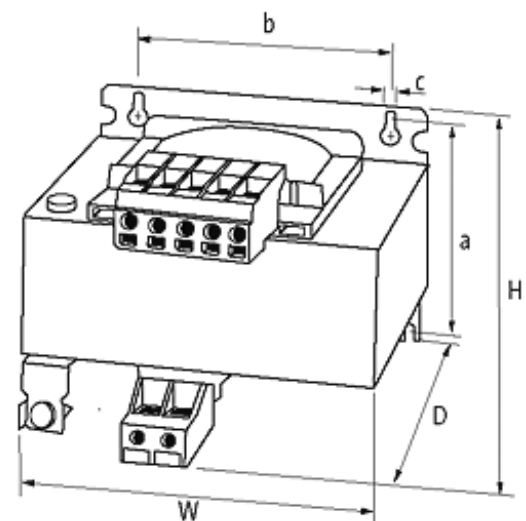
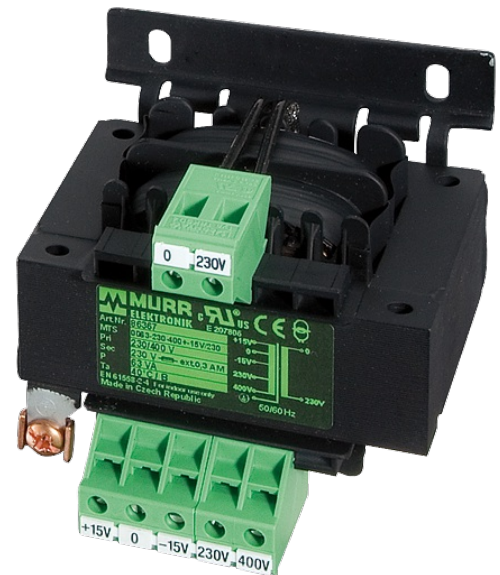

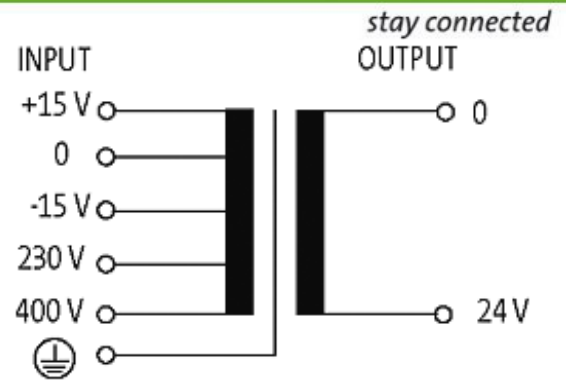

Product may differ from Image

Approvals



Input

Input voltage	230/400 ±15 V AC
Frequency	50...60 Hz
Input current	0.82 A (230 V AC); 0.47 A (400 V AC)
Inrush current	6.1 A (230 V AC); 3.5 A (400 V AC)
Short-circuit current	9.5 A (230 V AC); 5.5 A (400 V AC)

General data

Standards	EN 61558-1, EN 61558-2-6, EN 62041 category 0
Test isolation voltage	4 kV (prim./sec.)
Mounting method	Long-hole mounting or DIN-rail mountable TH35 (EN 60715)
Temperature range	-20...+40 °C (storage temperature -40...+80 °C)
Dimensions H × W × D	101×96×106 mm
Fixing centers a × b × c	86.5×84×4.8 mm
Drill hole Ø	4.8×8.4 mm

Output

Output voltage	24 V AC (SELV)
Output rating	160 VA

Commercial data

country of origin	CZ
customs tariff number	85043180
EAN	4048879078429
eClass	27031302
Packaging unit	1