

MTL 1-PHASE SAFETY TRANSFORMER

P: 40VA IN: 230/400VAC +/- 15VAC OUT: 2x24VAC

40 VA

Isolation class T 60/B

[Link to Product](#)

Illustration

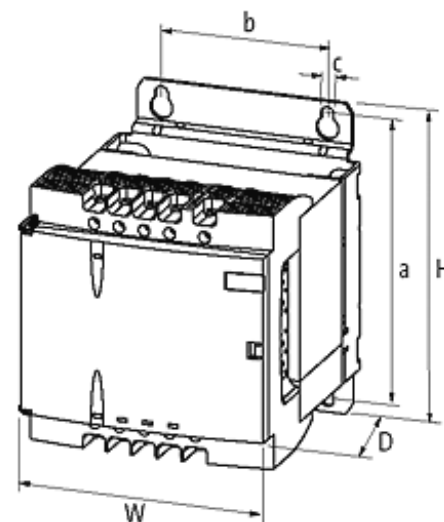

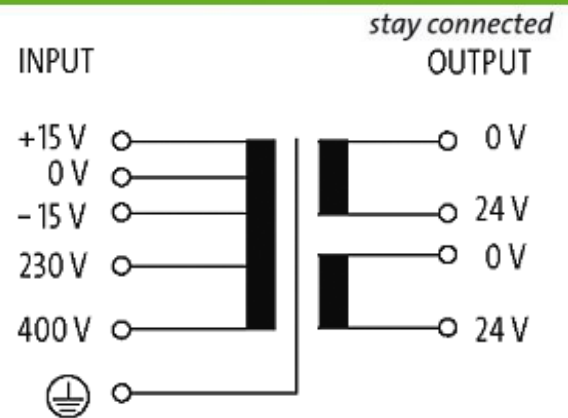

Product may differ from Image

Approvals



Input

Input voltage	230/400 ±15 V AC
Input current	0.26 A (230 V AC); 0.15 A (400 V AC)
Inrush current	2.96 A (230 V AC); 1.71 A (400 V AC)
Short-circuit current	3.2 A (230 V AC); 1.85 A (400 V AC)
Frequency	50...60 Hz

Technical Data

LED display	LED (green) for input voltage
-------------	-------------------------------

General data

Test isolation voltage	5.1 kV (prim./sec.)
Standards	EN 61558-2-4, EN 61558-2-6, EN 62041 category 0
Drill hole Ø	5.5×9 mm
Fixing centers a × b × c	96×60×5.5 mm
Mounting method	DIN-rail mountable TH35-15 (EN 60715) or for key-hole mounting
Dimensions H × W × D	108×87×104 mm
Temperature range	-20...+60 °C, no condensation

Output

Output voltage	1 × 24, 1 × 48, 2 × 24 V AC
Output rating	40 VA

Commercial data

country of origin	CZ
customs tariff number	85043180
EAN	4048879078344
eClass	27031302
Packaging unit	1

